

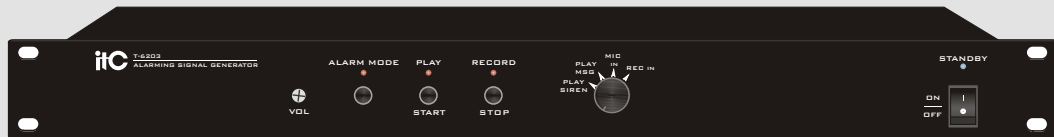

# PUBLIC ADDRESS SYSTEM

# OPERATION MANUAL

## T-6203 ALARMING SIGNAL GENERATOR



Please follow the instructions in this manual to obtain the optimum results from this unit. We also recommend that you keep this manual handy for future reference.

# TABLE OF CONTENTS

<b>1. SAFETY PRECAUTIONS</b> .....	3
<b>2. GENERAL DESCRIPTION</b> .....	5
<b>3. FEATURES</b> .....	5
<b>4. NOMENCLATURE AND FUNCTIONS</b>	
4.1 Front Panel .....	6
4.2 Rear Panel .....	6
<b>5. MACHINE OPERATION</b> .....	7
<b>6. APPLICATIONS</b> .....	8
<b>7. SPECIFICATIONS</b> .....	9
<b>8. DIMENSIONAL DIAGRAM</b> .....	10

# 1. SAFETY PRECAUTIONS

- Be sure to read the instructions in this section carefully before use.
- Make sure to observe the instructions in this manual as the conventions of safety symbols and messages regarded as very important precautions are included.
- We also recommend you keep this instruction manual handy for future reference.

## Safety Symbol and Message Conventions

Safety symbols and messages described below are used in this manual to prevent bodily injury and property damage which could result from mishandling. Before operating your product, read this manual first and understand the safety symbols and messages so you are thoroughly aware of the potential safety



### WARNING

Indicates a potentially hazardous situation which, if mishandled, could result in death or serious personal injury.



### CAUTION

Indicates a potentially hazardous situation which, if mishandled, could result in moderate or minor personal injury, and/or property damage.



### WARNING

#### When Installing the Unit

- Do not expose the unit to rain or an environment where it may be splashed by water or other liquids, as doing so may result in fire or electric shock.
- Use the unit only with the voltage specified on the unit. Using a voltage higher than that which is specified may result in fire or electric shock.
- Do not cut, kink, otherwise damage nor modify the power supply cord. In addition, avoid using the power cord in close proximity to heaters, and never place heavy objects -- including the unit itself -- on the power cord, as doing so may result in fire or electric shock.
- Be sure to replace the unit's terminal cover after connection completion. Because high voltage is applied to the speaker terminals, never touch these terminals to avoid electric shock.
- Be sure to ground to the safety ground (earth) terminal to avoid electric shock. Never ground to a gas pipe as a catastrophic disaster may result.
- Avoid installing or mounting the unit in unstable locations, such as on a rickety table or a slanted surface. Doing so may result in the unit falling down, causing personal injury and/or property damage.

#### When the Unit is in Use

- Should the following irregularity be found during use, immediately switch off the power, disconnect the power supply plug from the AC outlet and contact your nearest **ITC** dealer. Make no further attempt to operate the unit in this condition as this may cause fire or electric shock.
  - If you detect smoke or a strange smell coming from the unit.
  - If water or any metallic object gets into the unit
  - If the unit falls, or the unit case breaks
  - If the power supply cord is damaged (exposure of the core, disconnection, etc.)
  - If it is malfunctioning (no tone sounds.)
- To prevent a fire or electric shock, never open nor remove the unit case as there are high voltage components inside the unit. Refer all servicing to your nearest **ITC** dealer.
- Do not place cups, bowls, or other containers of liquid or metallic objects on top of the unit. If they accidentally spill into the unit, this may cause a fire or electric shock.
- Do not insert nor drop metallic objects or flammable materials in the ventilation slots of the unit's cover, as this may result in fire or electric shock.

### CAUTION

#### When Installing the Unit

- Never plug in nor remove the power supply plug with wet hands, as doing so may cause electric shock.
- When unplugging the power supply cord, be sure to grasp the power supply plug; never pull on the cord itself. Operating the unit with a damaged power supply cord may cause a fire or electric shock.
- When moving the unit, be sure to remove its power supply cord from the wall outlet. Moving the unit with the power cord connected to the outlet may cause damage to the power cord, resulting in fire or electric shock. When removing the power cord, be sure to hold its plug to pull.
- Do not block the ventilation slots in the unit's cover. Doing so may cause heat to build up inside the unit and result in fire.
- Avoid installing the unit in humid or dusty locations, in locations exposed to the direct sunlight, near the heaters, or in locations generating sooty smoke or steam as doing otherwise may result in fire or electric shock.

#### When the Unit is in Use

- Do not place heavy objects on the unit as this may cause it to fall or break which may result in personal injury and/or property damage. In addition, the object itself may fall off and cause injury and/or damage.
- Make sure that the volume control is set to minimum position before power is switched on. Loud noise produced at high volume when power is switched on can impair hearing.
- Do not operate the unit for an extended period of time with the sound distorting. This is an indication of a malfunction, which in turn can cause heat to generate and result in a fire.
- Contact your ITC dealer as to the cleaning. If dust is allowed to accumulate in the unit over a long period of time, a fire or damage to the unit may result.
- If dust accumulates on the power supply plug or in the wall AC outlet, a fire may result. Clean it periodically. In addition, insert the plug in the wall outlet securely.
- Switch off the power, and unplug the power supply plug from the AC outlet for safety purposes when cleaning or leaving the unit unused for 10 days or more. Doing otherwise may cause a fire or electric shock.

An all-pole mains switch with a contact separation of at least 3 mm in each pole shall be incorporated in the electrical installation of the building.

Due to product upgrades, while some of the features and specification in the user manual does not match the actual functions, sorry for any inconvenience and thanks for your kind understanding!

## 2. GENERAL DESCRIPTION

The T-6203 is a public address emergency panel with can provide an ideal public address solution from small to big places such us mosques, schools, hotels and factories to train stadium and air stations.

## 3. FEATURES

- 1.With alarm trigger and siren output.
- 2.One minute's recording/IC for playing music.
- 3.Output volume control.
- 4.2 optional alarm modes.

## 4. NOMENCLATURE AND FUNCTIONS

### 4.1 FRONT PANEL

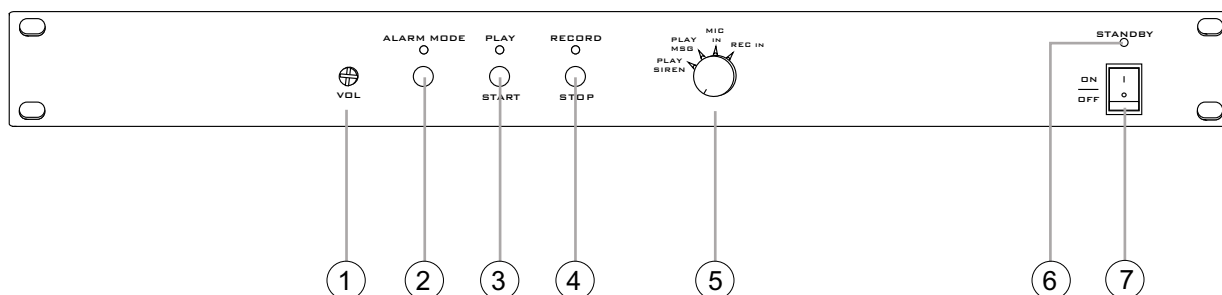

#### 1. VOL

Recording volume control

#### 2. ALARM MODE

The alarm for a certain choice

#### 3. START

Start / suspended, or put the sound recording

#### 4. STOP

Stop recording, setting the tone or options  
Optiona

#### 5. SELECTION SWITCH

Siren: Siren alarm signal output

Fang recording: Audio alarm output Curing

Recording: MIC -Microphone recording

LINE-Line recording

#### 6. POWER

Power indicator

#### 7. STANDBY SWITCH

1: Always power indicator light, keyboard operable

0: Power indicator light flashes, the keyboard can not operate

### 4.2 REAR PANEL

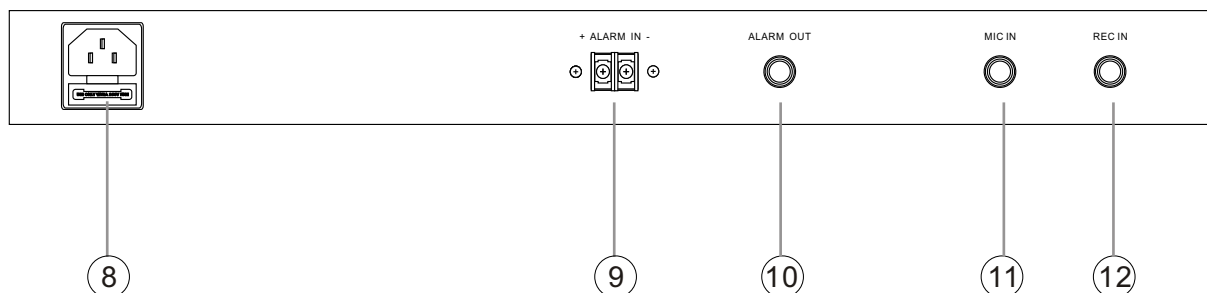

#### 8. AC POWER INPUT

#### 9. ALARM IN

Alarm signal input

#### 10.ALARM OUT

Alarm signal output

#### 11.MIC IN

Microphone input

#### 12.REC IN

Audio line input

## 5. MACHINE OPERATION

### MANUALLY OPERATION

1. When the machine stands in the state of working.  
(1)Siren alarms :when you set the optional switch at siren ,press play knob ,then it has a short siren output;press alarm mode and select longalarm mode,press play knob again,and it has a long siren output.

(2)Play recording to alarm: when you set the optional switch at MSG, press play knob, it has a recording sound output; press alarm mode and select longalarm mode , press play knob again , then the recording will be outputted repeatedly.

2 . When the machine stands standby, you can't play siren or recording manually.

### AUTOMAITC MODE

1. Siren alarms : when you set the optional switch at SIREN,if you input a trigger signal in the siren spigot at the real panel, and the output spigot won't output siren signals till the trigger signal is relieved

(1)Play recording alarm : set the optional switch at MSG , if there is a trigger signal being inputted in the siren spigot at the real panel , then the output spigot OUTPUT will output recorded signals , you can press STOP to cancel alarm according to the alarm mode by your command.)

(2)Play recording to alarm: when you set the optional switch at MSG, press play knob, it has a recording sound output ; press alarm mode and select long-alarm mode , press play knob again , then the recording will be outputted repeatedly.

(3)When you haven't cancelled the input trigger signals in the alarm spigot at the real panel,and place the optional switch at SIREN or MSG, you can get corresponding input

2. When the machine stands standby, the STOP knob can't work, others are as above.

### Recording operation:

Before recording , you need erase the whole recording, and then record,the detailed steps are as follows:

1.Place the optional switch at LINE or MIC.

2 .Press START and STOP simultaneously and keep it for more than 3 seconds till the PLAY/ RECORD indicator light is ON simultaneously.

3 .PLAY indicator light is ON and RECORD light is OFF,it express finished the erasure and the CMOS chip is empty.

4. According to the record audio,place the option switch at the LINE AND MIC (make the switch and channel relatively), and press the START to startup record.At this moment, PLAY light is OFF, RECORD light is ON.

5. CMOS chip is recorded fully or press the STOP key,the RECORD light is off.The chip can record one minute at the most.

6. After finish the record, make the option switch turn to PLAY MSG to play.

# 6. APPLICATIONS

## REAR PANEL CONNECTIONS

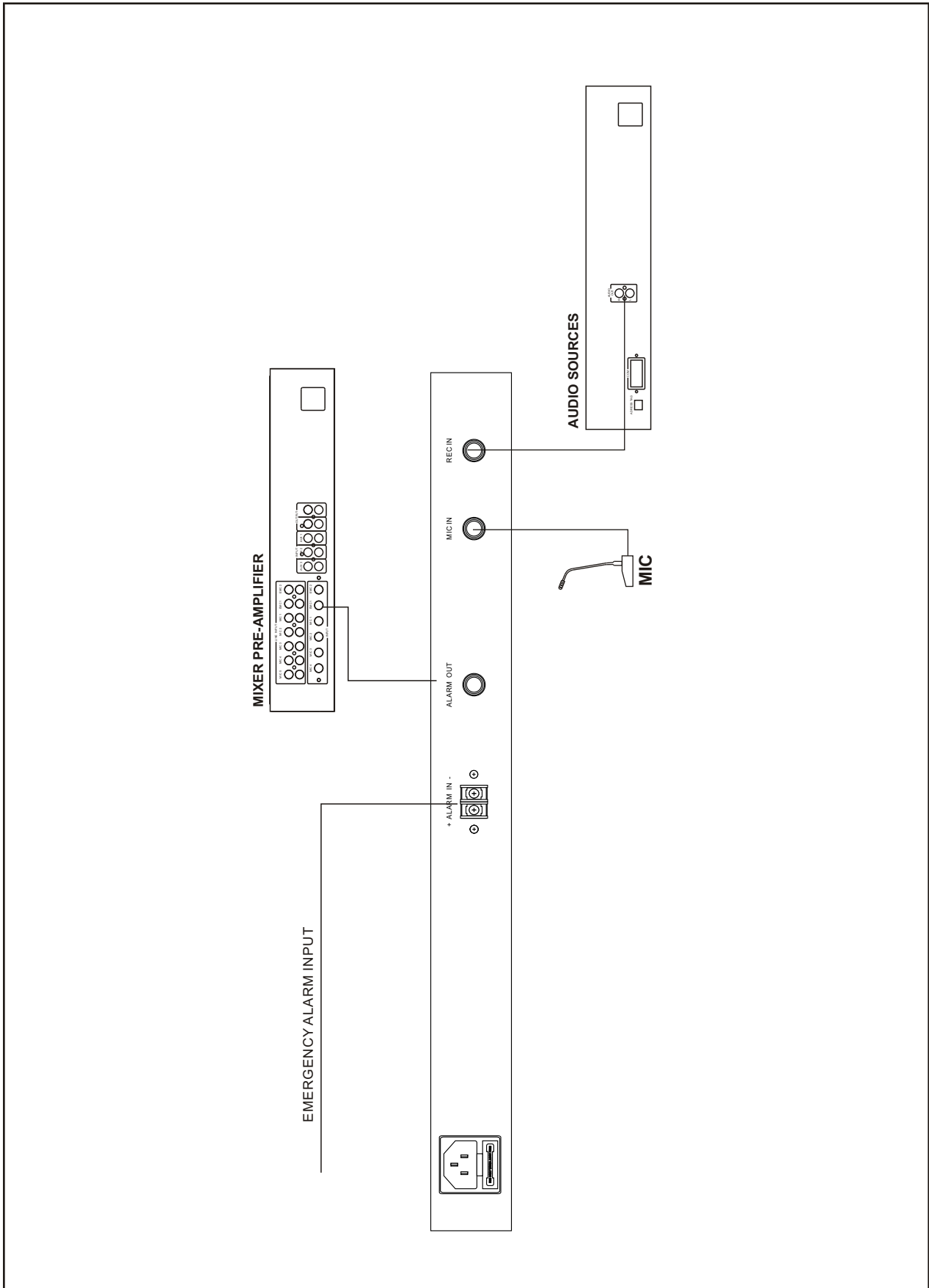

## 7.SPECIFICATIONS

EMERGENCY PANEL	
MODEL	T-6203
INDICATORS	Power LED/Alarm work of the police state of indicator
POWER REQUIREMENTS	~220-240V 50/60Hz
POWER CONSUMPTION	30W
DIMENSION(mm)	484X209X44
NET WEIGHT	4Kg
GROSS WEIGHT	5.2Kg

## 8. DIMENSIONAL DIAGRAM

UNIT:mm

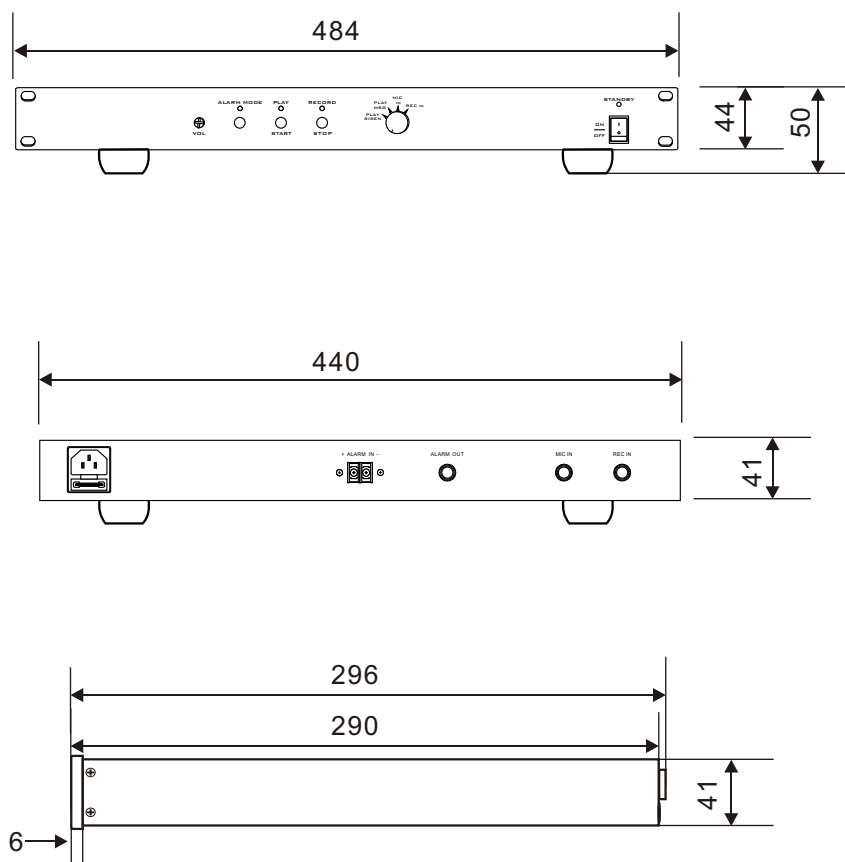

Keep the unit's all sides over 10 cm away from objects that may obstruct air flow to prevent the unit's internal temperature rise.

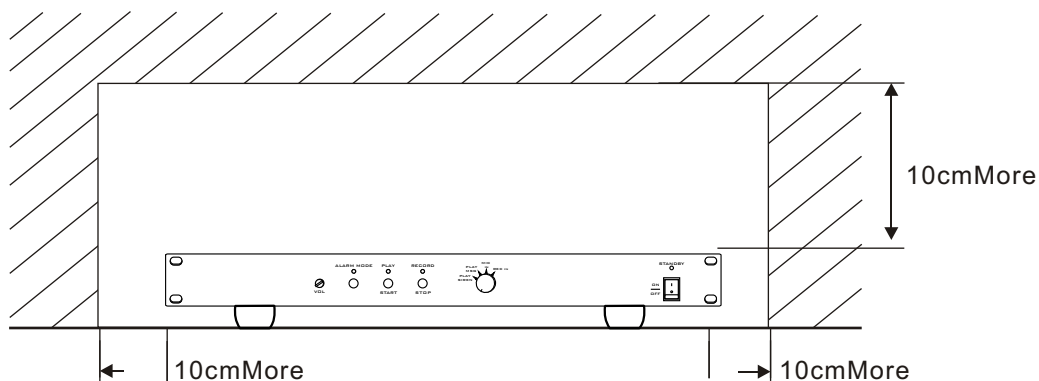

# PUBLIC ADDRESS SYSTEM

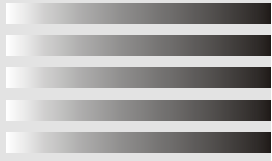

# Other ManualsLib Projects



[www.manualslib.com](http://www.manualslib.com)



[www.manualslib.de](http://www.manualslib.de)



[www.manualslib.es](http://www.manualslib.es)



[www.manualslib.fr](http://www.manualslib.fr)



[www.manualslib.nl](http://www.manualslib.nl)



[www.manualslib.mx](http://www.manualslib.mx)



[www.manualslib.tech](http://www.manualslib.tech) 30+ Languages