



DSPPA

DIGITAL CONFERENCE SYSTEM

Digital Conference Systems

2025-2026



Guangzhou DSPPA Audio Co., Ltd.

Address
NO.1 Xiahe Road, Jianggao, Baiyun,
Guangzhou, Guangdong, China

Email
export@dsppa.com
Conference@dsppa.com

Tel
+86-20-37166520

Website
www.dsppacs.com

Empower Efficient Conference
Embrace Win-win Cooperation



Guangzhou DSPPA Audio Co., Ltd. is a professional audio manufacturer since 1988. With more than 38 years' history of designing and manufacturing professional audio & video products, DSPPA has enjoyed a high reputation in and out of China. Technology innovations, strict quality and environment control (ISO 9001 & ISO14000) and market-oriented products have made DSPPA to be the leading brand in the field of public address system and conference system. As the chief editor of the Technical Standard for Public Address System Engineering of China, DSPPA is widely recognized as the largest and most professional audio equipment supplier in China.

- » DSPPA Production Range
- » IP Conference System
- » Digital Conference System
- » 5G WiFi Conference System
- » Conference Microphone System
- » Paperless Conference System
- » HD Visualization Distributed System
- » Video Meeting Conference System
- » Central Control System
- » Simultaneous Interpretation System

Factory 85000 m ² + 2 production centers	Head office 20000 m ²	Warehouse 6000 m ²	Factory 500+ people	Sales Team 300+ people	QC Dept 80+ people	R&D Engineers 260+ people
--	--	---	-------------------------------	----------------------------------	------------------------------	---



Product Advantage
Wide range of products and adequate stocks

Production Advantage
Automatic production and strict quality control

Technology Advantage
Outstanding technological innovation capability, hundreds of patents

Design Advantage
Brilliant R&D team, OEM/ODM available

Service Advantage
Professional pre-sales & after-sales service, strong technical support

Logistics Advantage
Large warehouse and sufficient worker to ensure fast and timely delivery

The Official Supplier of Audio Equipment for Two Consecutive Asian Games



Official Supplier for the Asian Games Hangzhou 2022
Official Supplier of Audio Equipment for the 19th Asian Games Hangzhou 2022



The Official Support Partner of the 18th Asian Games
The Exclusive Public Address and Intelligent Conference System of the 18th Asian Games



The 18th Asian Games, also known as Jakarta Palembang 2018, is a Pan-Asian multi-sport event held in Jakarta and Palembang, Indonesia from 18 August to 2 September, 2018. Due to the popularity and reputation of its products, DSPPA becomes the official support partner and the exclusive supplier of the public address and intelligent conference system for the event. A large amount of PA audio equipment is sponsored to venues across four provinces in Indonesia: Jakarta, South Sumatra, Banten, and West Java. Better PA service is provided by DAPPA for the 18th Asian Games.



20 R&D teams, 200+ engineers

DSPPA intends to be the most advanced global PA& Conference enterprise by continuous technical innovation and advanced quality management. Welcome to cooperate with us at all levels of collaborations, such as trades, distributions, OEM, ODM, technical cooperation, new products development and joint venture to realize win-win situation.



EASE(中国)声学设计与咨询有限公司
EASE (China) Acoustic Design and Consulting Limited.

公司介绍 应用培训 声学检测 声学设计

迪士普DSPPA

EASE 介绍 计算声学设计软件 - EASE
EASE 4.3 应用指南下载
EASE 培训网上的常见问题
计算声学设计软件
EASE 4 在建筑声学中的应用
聚焦声场设计软件(EASE)FOCUS 的应用
FOCUS 的应用
ADDRESS
EASERA
SYSTEMS
产品中心
我们的客户



The success of DSPPA is based on advanced technology, market-orientated strategy and insistent efforts. DSPPA is dedicated to providing the first-class products and service for worldwide clients.

RoHs Certificate
FCC Certificate
AEO Certificate

UL Certificate
CCC Certificate
Chief Editor of Technical Standard for public address system engineering

CE Certificate
IP66 Certificates

CB Certificate
ISO9001, ISO14000

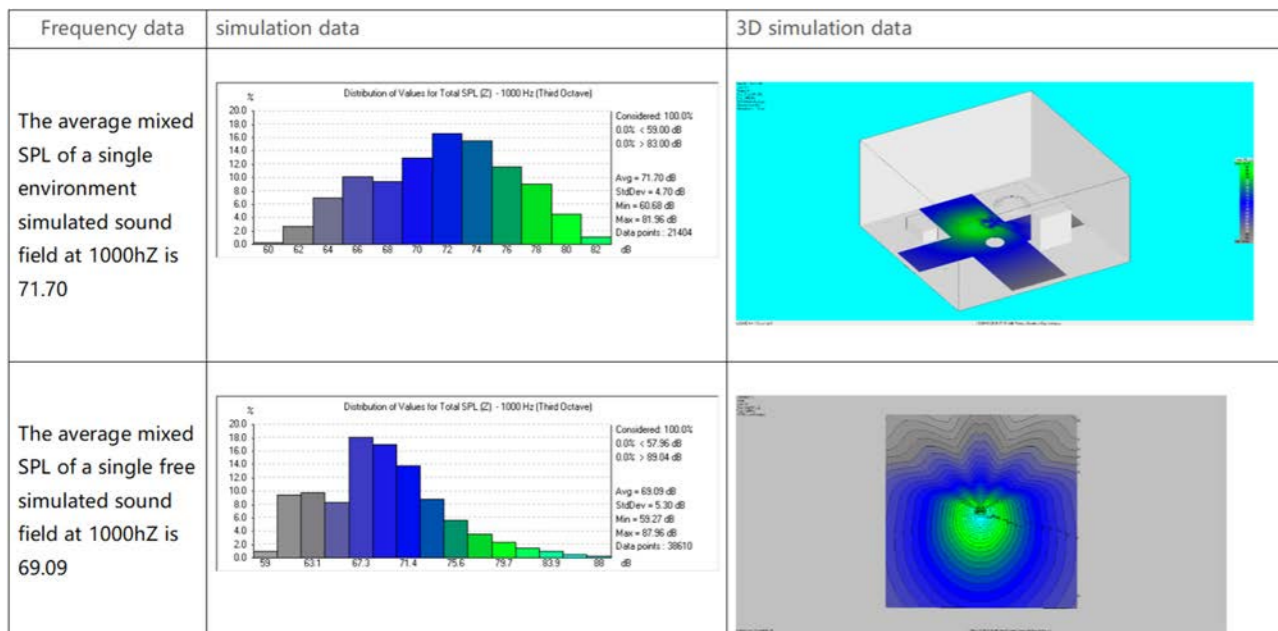

GB
中华人民共和国国家标准
P
GB/T 50526-2021

公共广播系统工程技术标准
Technical standard for public address system engineering

2021-04-09 发布 2021-10-01 实施

中华人民共和国住房和城乡建设部 联合发布
国家市场监督管理总局



Digital / IP Conference System



Distributed Central Control System

Simultaneous Interpretation System



IP Record and Broadcast System

4K Distributed Audiovisual Matrix System

4K Distributed KVM System

Fiber 4K Distributed KVM System



Pro Audio System



ASEAN International Conference Center in Laos



Conference for Arxan Forum at Inner Mongolia 2018

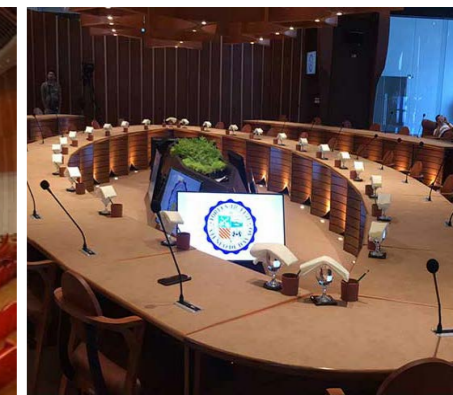

Conference System in Ateneo de Davao University Philippines



IP Conference System for Kompleks Satria Pertiwi, Malaysia



Ecological Management Committee of Dongguan Song Mountain Lake



Digital Conference System for Ministry of Agriculture in Sri Lanka



Digital Conference System for University of Peradeniya in Sri Lanka

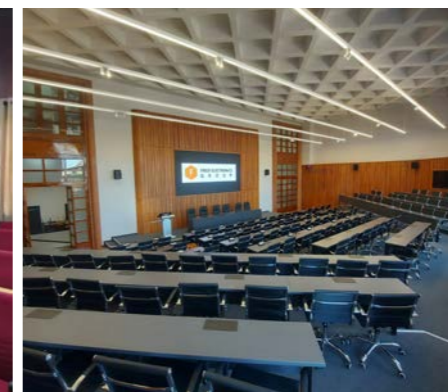

Simultaneous Interpretation System for The Polytechnic University of Tirana in Albania



Pro Audio System for Multifunctional Lecture Hall in UAE



Intelligent Conference System for the Department of Statistics in Malaysia



Professional Sound System for Army Auditorium in Bangladesh

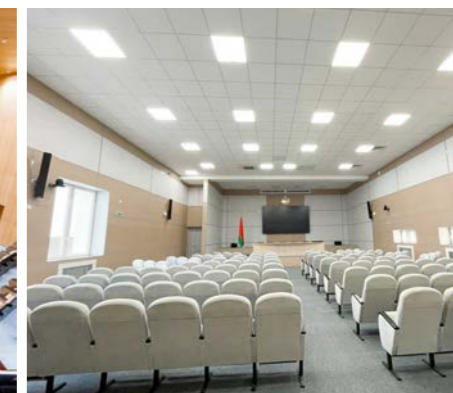

Phased Array Sound System for Grodno Labor Department in Belarus

AI Audiovisual Experience Center



CONTENTS

01 Audio Conference System

- 01 D6201 Intelligent Audio Conference System
- 18 D7111 Full Digital Conference System
- 21 MP9866 Digital Conference System

24 Wireless Conference System

- 24 D73 Series 5G WiFi Conference System
- 30 D58 UHF Conference Microphone System

33 Paperless Conference System

- 33 D7600 Digital Paperless Conference System
- 42 Dual Display E-Ink Screen Meeting Nameplate

44 Related Audiovisual System

- 44 D6108 2K Audiovisual Matrix System
- 51 DSP92 Recording and Broadcasting System
- 56 D7700 Video Meeting Conference System
- 59 Interactive Flat Panel

63 Central Control System

- 63 D6601 Distributed Central Control System

68 Simultaneous Interpretation System

- 68 D6391 Interpretation System

72 Peripherals

- 72 Digital Mixer / CD Player / Feedback Processor
- 74 AI Conference Microphone

- 12 D7101 IP Conference System
- 21 D7201 Dante Conference System
- 22 D6686 Immersive Conference System

- 28 D6850 2.4G Wireless Microphone System

- 42 D7022II Conference Electronic Nameplate

- 47 D6900 4K HD Visualization Distributed System
- 54 HD8000 Video Meeting Conference System
- 58 Screen Mirroring System

- 66 DSP6468 Multimedia Teaching Central Control System

- 70 D6215II Interpretation System

- 73 Sequence Controller

- 76 Conference Microphone

Discussion+Voting+Sign in+Interpretation+Video Tracking

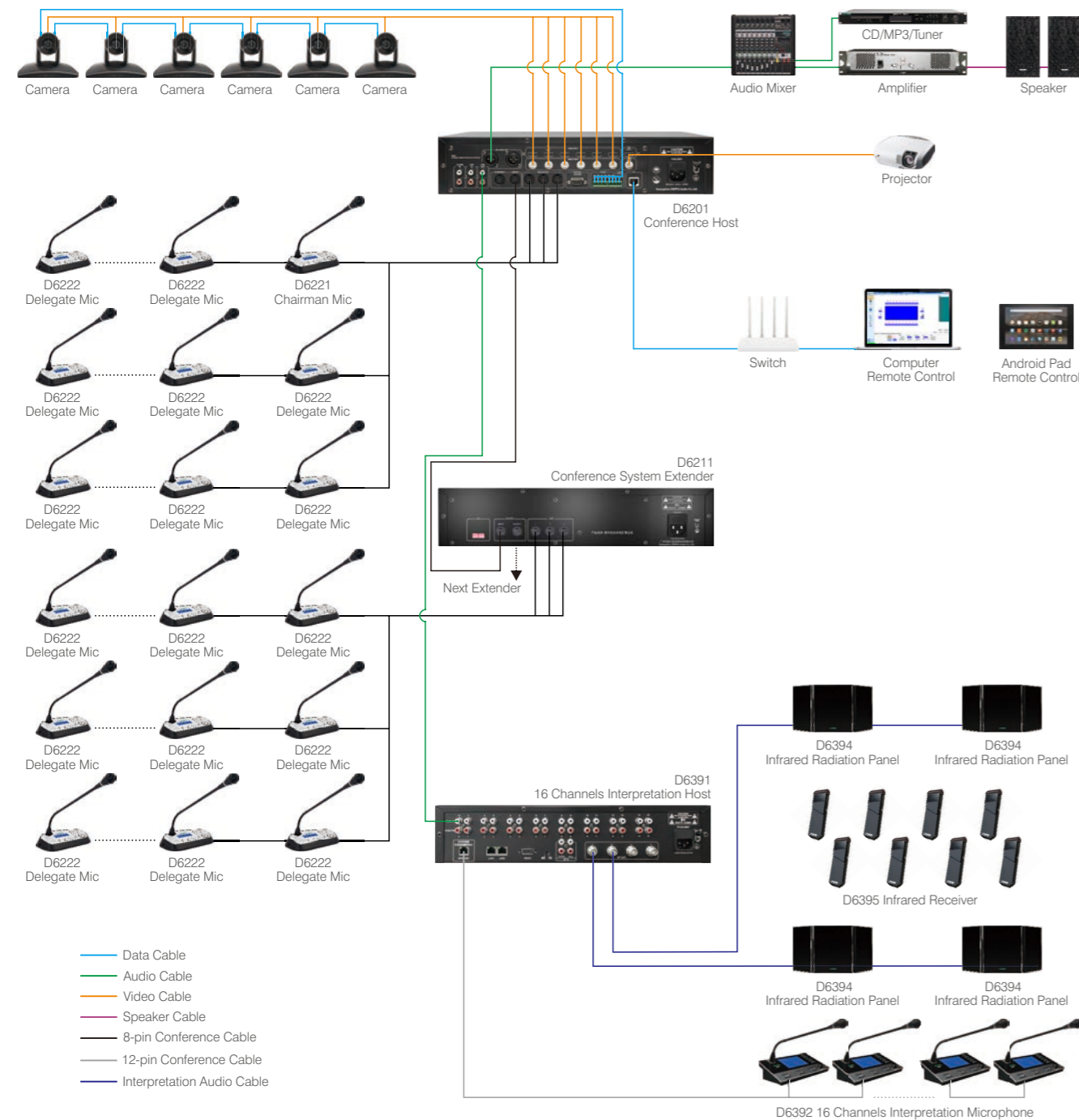

- 4.3 inch touch screen
- Speech, Sign-in, Voting, Statistic, System setting
- Built-in high-performance ARM processor
- Support mobile pad remote control via internet

- Built-in DSP processor and EQ adjustment
- Support automatic camera tracking function
- Max 4096pcs conference microphone
- Chairman mic with first priority

Application: Conference room, Court, Lecture hall, International Center, Stadium, Training room, etc.

D6200

D62 Series Intelligent Conference System Software

- Support WinXP/Win7/Win8/Win10 system
- Based on TCP/IP protocol, support both wired connection and wireless connection
- Can set up all the setting of the host D6201
- Meeting room layout design: support layout design as VISO & CAD, can synchronize to Android pad
- Support multiple agenda, meeting bills and sign-ups
- Meeting bills including 3 modes: Voting, Electing and Grading
- Support monitoring and meeting memo saving
- Support camera preview and multiple channels selection
- Support camera tracking for the speaker, support video shooting and screen shots and save in computer



Conference layout design



Conference host set-up

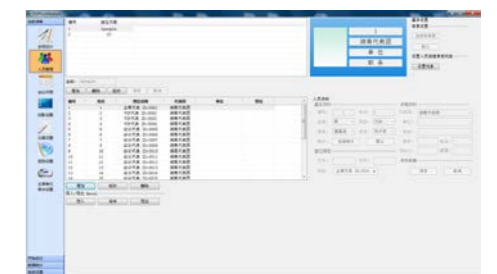

Conference Mic setting

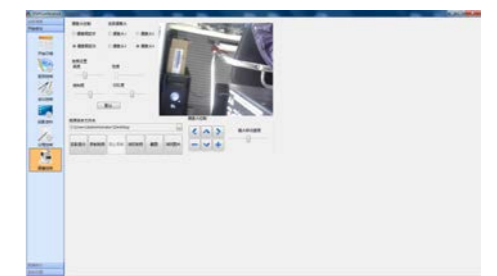

Cameras set-up

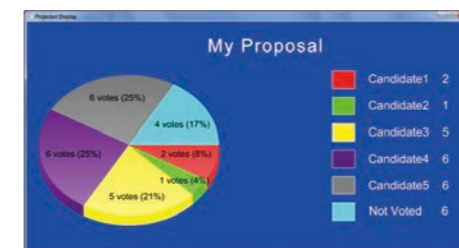

Meeting bills

D6201C

Intelligent Conference Host with Matrix Switch



- Connect 128 mic, max 4096 mic
- Five conference modes: FIFO, NORMAL, VOICE, FREE, APPLY
- 4.3" TFT touch screen
- Split Mode on HDMI output 1 and Matrix Mode on HDMI outputs 1 and 2 Supported
- VIP Mic setting (up to 20)
- 8-pin conference cable, support cascaded connection
- Support simultaneous speakers limit setting of 1/2/3/4/5/6
- DSP sound processor
- Conference recording and speech timing function
- Support video camera tracking
- With RS232 and RS422 interface
- Support Android pad remote control

Matrix Mode Supported by HDMI Outputs 1 and 2



Split Mode Supported by HDMI Output 1

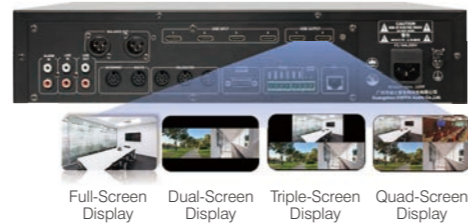

D6201

Intelligent Conference Host



- Connect 128 mic, max 4096 mic
- Five conference modes: FIFO, NORMAL, VOICE, FREE, APPLY
- 4.3" TFT touch screen
- VIP Mic setting (up to 20)
- 8-pin conference cable, support cascaded connection
- Support simultaneous speakers limit setting of 1/2/3/4/5/6
- DSP sound processor
- Conference recording and speech timing function
- Support video camera tracking
- With RS232 and RS422 interface
- Support Android pad remote control

D6211

Intelligent Conference Mic Extender



- Conform to IEC 60914 international standard
- Conference system Mic extender
- One D62000 system support up to 32 extenders
- One extender can connect with 128 Mic

D5901

Compact Digital Conference Host



- With 2.0" TFT screen to display working status
- Support five conference modes: FIFO, FREE, NORMAL, APPLY, and VOICE
- With limit (1/2/3/4/5/6) settings for simultaneous speaking units
- Support five conference modes: FIFO, FREE, NORMAL, APPLY, and VOICE
- Can connect up to 30 D62 series speaking-only units
- With volume adjustment for the output signal level
- Can set a time limit and an end reminder for the timing speaking
- Can set 3 alert tones for when the unit is pressed
- With podium mode and priority function for the chairman unit
- With two 8-pin DIN aviation female connectors, connected to conference units
- The system host integrates a camera tracking system, enabling automatic camera tracking functionality
- Equipped with one RS232 serial port for seamless integration with a central control system or for connecting to a camera control cable for camera control
- Two RCA jacks (unbalanced output) and two XLR jacks (balanced output) for connection to professional power amplifiers

D6221 / D6222 / D6223 / D6224

Desktop Microphone with Voting Function (D6221/D6222)



- Chairman Mic with priority function
- With camera tracking function
- Two colors indicators, red for speaking, green for applying to speak
- Built-in Hi-Fi speaker, will be muted automatically when the Mic is turned on to avoid whistling
- 3.5mm stereo earphone jack, volume adjustable
- With 5 buttons for voting, with sign-in function
- Every Mic with unique ID code, can be set up via host D6201
- D6221/D6222 built-in LCD screen, can display information as Mic ID, voting result, sign-in number, etc.
- Support cascaded linkage, T shape linkage or + shape linkage

D6271 / D6272 / D6273 / D6274

Desktop Microphone with Voting Function (D6271/D6272)



- Speech, sign-in and voting function (D6271/D6272)
- 2.1" circular LCD display touch screen (D6271/D6272)
- With 3.5mm stereo headphone jack for monitoring
- Adjust the microphone volume independently
- With a unique ID for each conference unit
- 3 sets of theme UI, switched freely
- Used with a camera to realize automatic camera tracking
- The chairman unit has the priority function



D6275 / D6276 / D6277 / D6278

Dual Backup Desktop Microphone with Voting Function (D6275/D6276)



- Speech, sign-in and voting function (D6275/D6276)
- 2.1" circular LCD display touch screen (D6275/D6276)
- With microphone output dual backup function
- With 3.5mm stereo headphone jack for monitoring
- Adjust the microphone volume independently
- With a unique ID for each conference unit
- 3 sets of theme UI, switched freely
- Used with a camera to realize automatic camera tracking
- The chairman unit has the priority function



D5923 / D5924

Desktop Conference Unit



- Power supply DC24V via host
- Chairman unit has a priority button
- Multiple chairman units can coexist without wiring position limitations
- Equipped with a DIN8 microphone interface
- LED indicator displays real-time working status
- Strong anti-interference capability

D6225 / D6226

Desktop Array Chairman/Delegate Microphone



D6225 Chairman Mic



D6226 Delegate Mic

- Built-in 17 highly directional and highly sensitive array microphone with high resolution degree of human voice
- Touch-screen on/off button and chairman priority button
- 3.5 mm earphone output on the left side
- 8 pin conference cable on the bottom, support cascade connection with host D6201
- Support simultaneous use with D6221/6222
- Pickup distance up to 80cm, simple and exquisite

D6225FS / D6226FS

Flip Digital Array Unit



D6225FS
Chairman Unit



D6226FS
Delegate Unit

- Built-in 17 high sensitive array microphone
- With rollover control system to meet one-key up and down
- Touch-screen on/off button
- 3.5 mm earphone output on the left side
- 8 pin conference cable for connecting with other microphone
- Pickup distance up to 80cm
- D6225FS chairman mic with first priority

D6251 / D6252

Embedded Microphone with Voting Function



D6251 Chairman Mic



D6252 Delegate Mic

- Speech, voting function
- 3.5mm stereo earphone jack
- 5 buttons for voting, with sign-in function
- Built-in LCD screen
- Camera tracking function
- Power supply DC24V via host
- Strong anti-interference capability
- Chairman Mic D6251 with priority function
- Cutout size: 201x71mm

D6253 / D6254

Embedded Speech Microphone



D6253
Chairman Mic



D6254
Delegate Mic

- 3.5mm stereo earphone jack
- Camera tracking function
- Power supply DC24V via host
- Support cascaded linkage
- Strong anti-interference capability
- Chairman Mic D6253 with priority function
- Cutout Size: 72x72mm

D6237

Connecting Box for Embedded Units



- Conform to IEC 60914 international standard
- One D6237 contains 2 ID, one ID can connect one microphone unit & one voting unit
- Support cascaded linkage and loop connection
- Support plug-and-play, easy to use
- 8-pin DNC standard jack for control signal, RJ45 jack for Mic and voting units
- Power supply from the host/extender, working power DC 24V

D6239

Microphone Extend Power Supplier



- Conform to IEC 60914 international standard
- Power supply extender for Mic and voting units
- With LED indicator to display working status and fault
- 4 channels output, total power output 350W

D6260 / D6261 / D6262 / D6263 / D6264 / D6265

Conference 8-pin DIN Wire



- 8-pin high-density cable, stable and reliable
- One male jack and one female jack for connection
- D6260(2m), D6261(5m), D6262(10m), D6263(20m), D6264(50m), D6265(100m)

D6266

Conference Dual-male Wire



- Professional 8-pin DIN cable
- Both ends are male interfaces
- Can be used between conference host and extenders, conference host and microphones, conference host and power extender, etc.
- Default length is 2m, extender wires are available

D6283II

Conference Camera (High Definition)



- 1/2.8 inches high quality image sensor, maximal 1920×1080 resolution, output frame rate 60fps
- 12, 20 or 30 times optical lens to choose
- Support HDMI HD output, 3G-SDI and wired LAN HD output
- Use RS232, RS485 or network to control cameras, support VISCA, PELCO-D, PELCO-P protocols
- Support image shielding when presetting position
- Support up to 255 preset positions

D6284

Conference Camera



- 2.14 million pixel 1/2.8 inch CMOS sensor
- Support H.265, H.264 network video encoding
- Support full HD 1080P video output
- Support 3G-SDI, DVI high-definition video output
- Built-in 2.4G/5G dual-band WIFI (optional)
- 20x optical zoom, maximum wide angle 59.5°
- Support dual stream and multi-level video quality configuration
- Support 1 channel audio input and 1 channel audio output
- Support up to 64G TF card local storage
- Equipped with multi-function IR remote control



D6267 / D6267B

Conference Desktop Socket/Conference Ground Socket



D6267

D6267B

- Pre-buried to connect with conference unit
- Interface: two 8-pin DCN male socket, one AC220V three-hole universal power supply socket
- All socket is insulated with earth wire. Please make sure ground wire is separated

D6269

Conference Cross Connector



- Cross connector for 8-pin DIN cable
- One 8-pin DIN input (male), three 8-pin DIN output (female)

D626A / D626C

5-Pin Conference Mic Pole (415mm)



D626B / D626D

5-Pin Conference Mic Pole (315mm)



Note: the length could be customized with 450, 480, 500mm



D627A
Squared Conference Mic Pole
(240mm, Silver gray)



D627B
Squared Conference Mic Pole
(240mm, Black)



D627C
Squared Conference Mic Pole
with Analog Backup
(240mm, Silver gray)



D627D
Squared Conference Mic Pole
with Analog Backup
(240mm, Black)



D629A
Dual Rods Squared Conference
Mic Pole
(240mm, Silver gray)



D629B
Dual Rods Squared Conference
Mic Pole
(240mm, Black)

D7101 Network Conference System

The D7101 Network Conference System integrated with discussion and speech, voting, meeting sign-in, electronic desktop nameplate, teleconference, automatic camera tracking, and full conference recording. Besides, it can support PC-based software remote conference control, and Android tablet wireless control. The system includes 3 connection methods for wired and wireless mics: 1. pure wired mic connection; 2. pure wireless mic connection; 3. wired and wireless mics hybrid connection. It's easy to install and using, suitable for high end conference meeting, remote conference meeting, Auditorium conference meeting and so on.

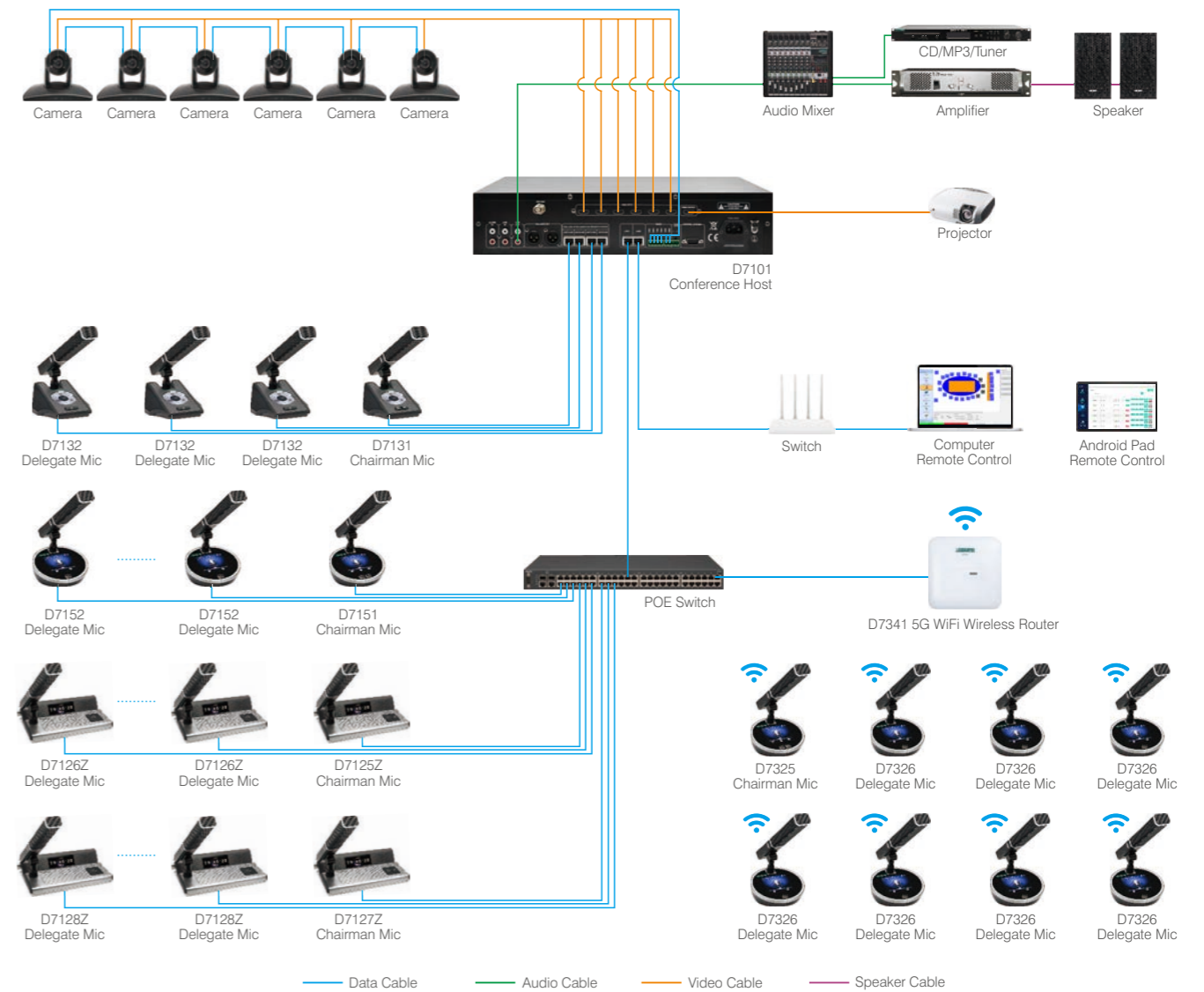

- 4.3 inch touch screen
- Speech, Sign-in, Voting, Statistic, System setting
- Microphone with nameplate
- Support mobile pad remote control via internet

- Built-in DSP processor and EQ adjustment
- Support automatic camera tracking function
- Max 4096pcs conference microphone
- Chairman mic with first priority

Application: Conference room, Court, Lecture hall, International Center, Stadium, Training room, etc.

D7101 Full Digital Conference System Host



- Distributed conferencing system, network protocol transmission(PCS Stream)
- Integrated with translation, discussion, sign in, vote, electronic nameplate and other function
- Support up to 4096 conference microphone
- The host with 4.3-inch resistance screen, and the unit with 2.42 inch OLED screen, and the nameplate is 3.9 inch LCD screen
- With 5 speech modes: FIFO, NORMAL, VOICE, Free, Apply, support up to 6 unit at the same time
- The participant information for units could be edited
- The host has the Main and Standby switching function
- Could be connection with 5G WiFi wireless conference system
- Support remote upgrade program

D7131 / D7132 / D7133 / D7134 Desktop Microphone with Voting Function (D7131/D7132)



D7131 Chairman Mic D7132 Delegate Mic



D7133 Chairman Mic D7134 Delegate Mic



(Customized)

- Integrated with speech, sign-in functions
- D7131/D7132 with voting and service calling functions
- 2.1-inch LCD screen display (D7131/D7132)
- With 3.5mm stereo headphone jack monitoring
- Adjusting the microphone volume independently
- With a unique ID for each conference unit
- The unit is powered by the system host or PoE switch 48V
- Chairman mic with priority function

D7135 / D7136 / D7137 / D7138 Dual Backup Desktop Microphone with Voting Function (D7135/D7136)



D7135 Chairman Mic D7136 Delegate Mic D7137 Chairman Mic D7138 Delegate Mic

- Integrated with speech, sign-in functions
- D7135/D7136 with voting and service calling functions
- D7135/D7136 with microphone output backup function
- 2.1-inch LCD screen display (D7135/D7136)
- With 3.5mm stereo headphone jack monitoring
- Adjusting the microphone volume independently
- With a unique ID for each conference unit
- The unit is powered by the system host or PoE switch 48V
- Chairman mic with priority function



D7151 / D7152 / D7153 / D7154 Desktop Conference Microphone with Voting Function (D7151/D7152)



D7151 Chairman Mic D7152 Delegate Mic



D7153 Chairman Mic D7154 Delegate Mic



(Customized)

- Integrated with speech, sign-in functions
- D7151/D7152 with voting and service calling functions
- 4-inch LCD touch screen display (D7151/D7152)
- With 3.5mm stereo headphone jack monitoring
- Adjusting the microphone volume independently
- With a unique ID for each conference unit
- The unit is powered by the system host or PoE switch 48V
- Chairman mic with priority function

D7121 / D7122 / D7123 / D7124

Desktop Network Conference Microphone with Voting Function (D7121/D7122)



D7121 Chairman Mic



D7122 Delegate Mic



(Customized)



D7123 Chairman Mic



D7124 Delegate Mic

- 2.42 inch OLED screen display (D7121/D7122)
- Adopting network protocol transmission, not compressed
- Powered by system host or normal switch
- With audio output interface and volume adjustment
- Connected via network cable
- Chairman mic with priority function

D7125Z / D7126Z / D7127Z / D7128Z

Desktop Network Conference Microphone with Voting Function (D7125Z/D7126Z) & Nameplate



D7125 Chairman Mic



D7126 Delegate Mic



(Customized)



D7127 Chairman Mic



D7128 Delegate Mic

- Adopting network protocol transmission, not compressed
- Powered by system host or normal switch
- Front panel with 2.9 inch LCD screen display
- With 3.9 inch LCD nameplate
- With audio output interface and volume adjustment
- The participant information and background could be edited
- Connected via network cable
- Chairman mic with priority function

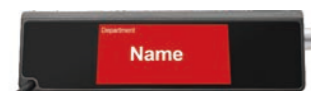

D7141 / D7142

Embedded Microphone with Voting



D7141 Chairman Mic



D7142 Delegate Mic

- Voting Chairman microphone
- Sign-in function
- Chairman mic with priority
- Powered by POE48V



(Customized)

D7143 / D7144

Embedded Speech Microphone



D7141 Chairman Mic



D7142 Delegate Mic

- 3.5mm headphone jack
- Chairman mic with priority
- Powered by POE48V
- Pure speech microphone



(Customized)

Accessory



D7287 Elliptical Conference Mic Pole (182mm)



D625M Square Conference Mic Pole (220mm)

D7129
Tracking Camera



- Support HDMI, 3G-SDI, USB3.0, CVBS outputs
- 12x optical zoom, 12x digital zoom
- 2 million pixels, Support 1920*1080P resolution
- Support RS232/RS485 interface control
- Support 3D digital noise reduction algorithms

D7139
Full Digital HD Tracking Camera



- Support HDMI, USB3.0, LAN outputs
- 12x optical zoom, panoramic lens:F=1.89mm
- 8.5 million pixels, Support 4K resolution
- Support RS232/VISCA/Pelco-D/P protocol control
- Support 3D digital noise reduction algorithms

D7149
Full Digital HD Tracking Camera



- Support HDMI, HD-SDI, USB3.0, IP outputs
- 12x optical zoom, 12x digital zoom
- 8.37 million pixels, Support 4K resolution
- Support RS232/RS485/VISCA/PELCO P/D/ONVIF/UDP interface control
- Support 3D digital noise reduction algorithms

D7109
8-Port Gigabit PoE Switch



- 8 Ports POE Switch
- Port rate: 10/100Mbps
- Total power: 120W
- Transport distance: 100meters

D7111 Full Digital Conference System

In modern conferences, seamless communication and premium audio are pivotal for efficiency. The D7111 Full digital Conference System, built on an ARM+FPGA platform, merges high-performance DSP audio processing with high-fidelity design, uniting advanced control and audio technologies.

This synergy enables precise digital control, top-tier audio transmission, and intuitive visual operation-delivering a comprehensive, high-quality conference solution. It elevates meetings of all scales, redefining digital conferencing by putting advanced technology at the service of clear, effective communication.

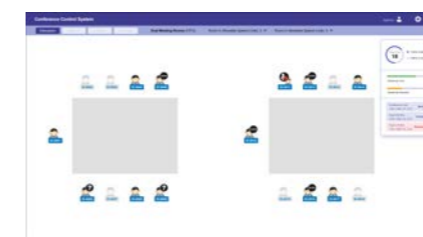
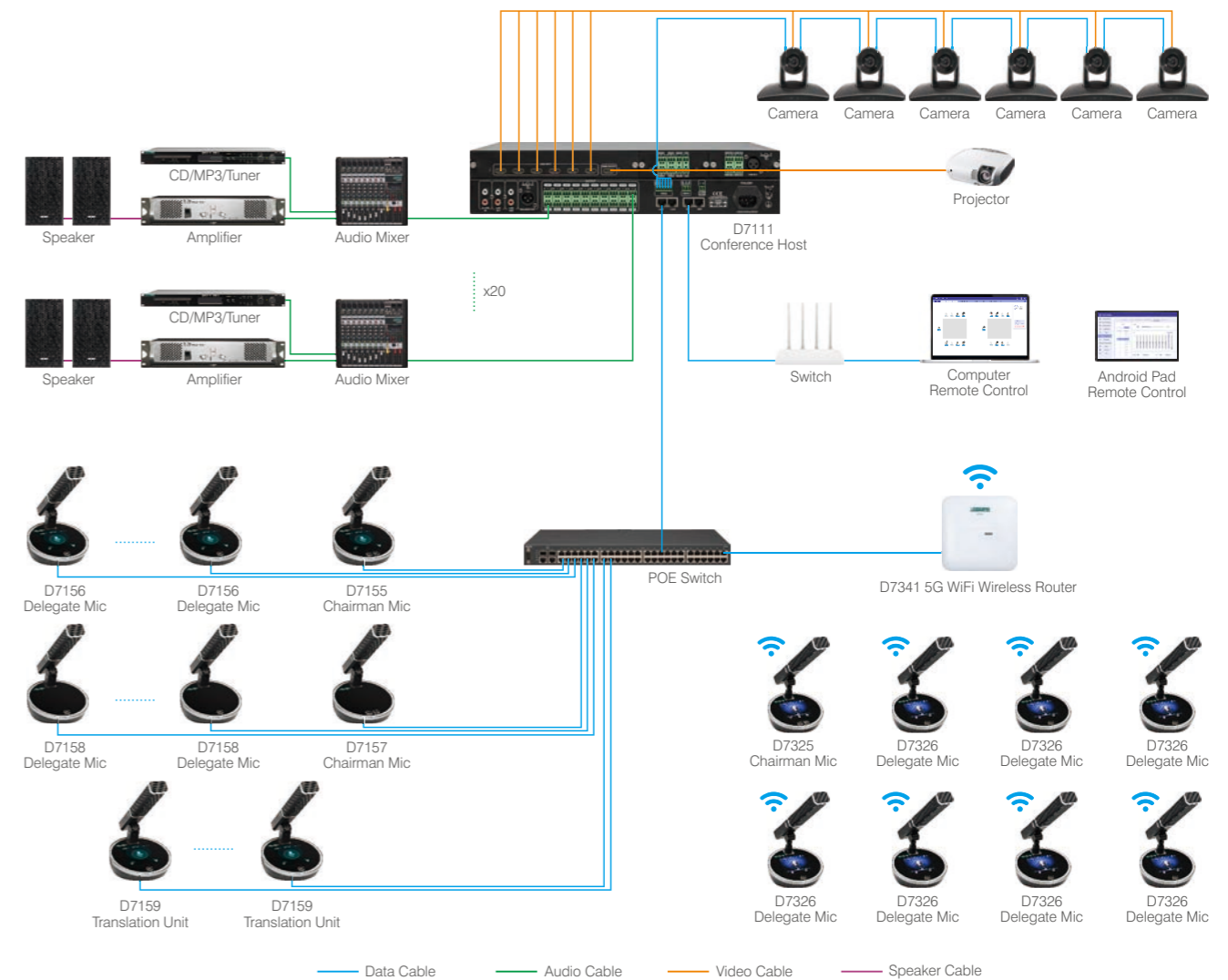

D7100P
Full Digital Conference System PC Software

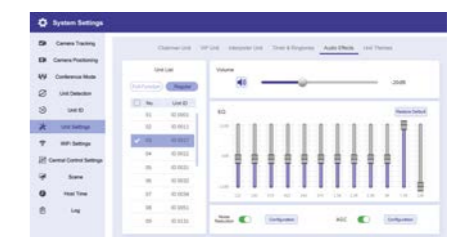

D7100W
Full Digital Conference System Web Software

D7111 Full Digital Conference System Host



- Adopting ARM+FPGA+DSP audio processing and network digital transmission solution
- Integrates functions such as speech, check-in, voting, rating, short messaging, tea service, and zone output
- DSP+FPGA processors, with 20-channel zone matrix + 1-channel mixed output
- 20-channel simultaneous interpretation output, with built-in matrix processor
- Supports mixed use of wired/wireless units, up to 6 chairman units + 32 VIP units
- Can connect 4096 wired + 300 wireless units after expansion
- Maximum speaking units: 24 purely wired / 6 purely wireless / 18+6 mixed
- Integrated camera tracking, with RS422-controlled cameras
- TCP/IP protocol, supporting C/S and B/S architectures
- 5 conference modes, supporting unit detection and speaking timing reminders

D7157 / D7158 Desktop Microphone



- Integrates functions such as speech, check-in
- 3.5mm stereo headphone jack for monitoring
- Independent volume adjustment for microphone/headphone, supporting 12-band EQ adjustment
- Supports microphone noise reduction and Automatic Gain Control (AGC)
- Powered by +48V (system host or PoE switch)
- Chairman Unit: Features priority right and podium mode
- Chairman Unit: No restriction on the number of speakers, with full authority to control meeting order

D7155 / D7156 Desktop Microphone with Voting Function



- Integrates functions such as speech, check-in, voting, rating, SMS, and tea service
- 4-inch square capacitive touchscreen, displaying the unit's working status in real time
- 3.5mm stereo headphone jack for monitoring
- Independent volume adjustment for microphone/headphone, supporting 12-band EQ adjustment
- Supports microphone noise reduction and Automatic Gain Control (AGC)
- Powered by +48V (system host or PoE switch)
- Chairman Unit: Features priority right and podium mode
- Chairman Unit: No restriction on the number of speakers, with full authority to control meeting order

D7159 Desktop Translation Unit



- Supports wired simultaneous interpretation, with a maximum of 6+1 language audio channels
- Supports external headset voice input, allowing switching between the headset and the microphone pole
- Equipped with a 4-inch square capacitive touchscreen, which displays the unit's working status in real time
- With a 3.5mm audio interface for connecting headphones or headsets
- Microphone volume and headphone monitoring volume can be adjusted independently
- Each translation unit has a unique ID number
- Features a cough suppression function to prevent cough sounds from being transmitted when the interpreter coughs
- Powered by the system host or PoE switch, with an input voltage of +48V

MP9866 Series Digital Conference System



- Small to medium digital conference system
- One controller support max 120 microphone units
- 2 channels outputs for microphone units connection
- Three working mode: First in first out, fully open mode, chairman mode
- Chairman Mic with priority function, with chairman only on/off options
- All of the equipment are connected hand by hand for easy wiring and maintenance
- Connected through 8 Pins conference cable or Cat-5 cable
- Equipped with recording output interface for conference recording

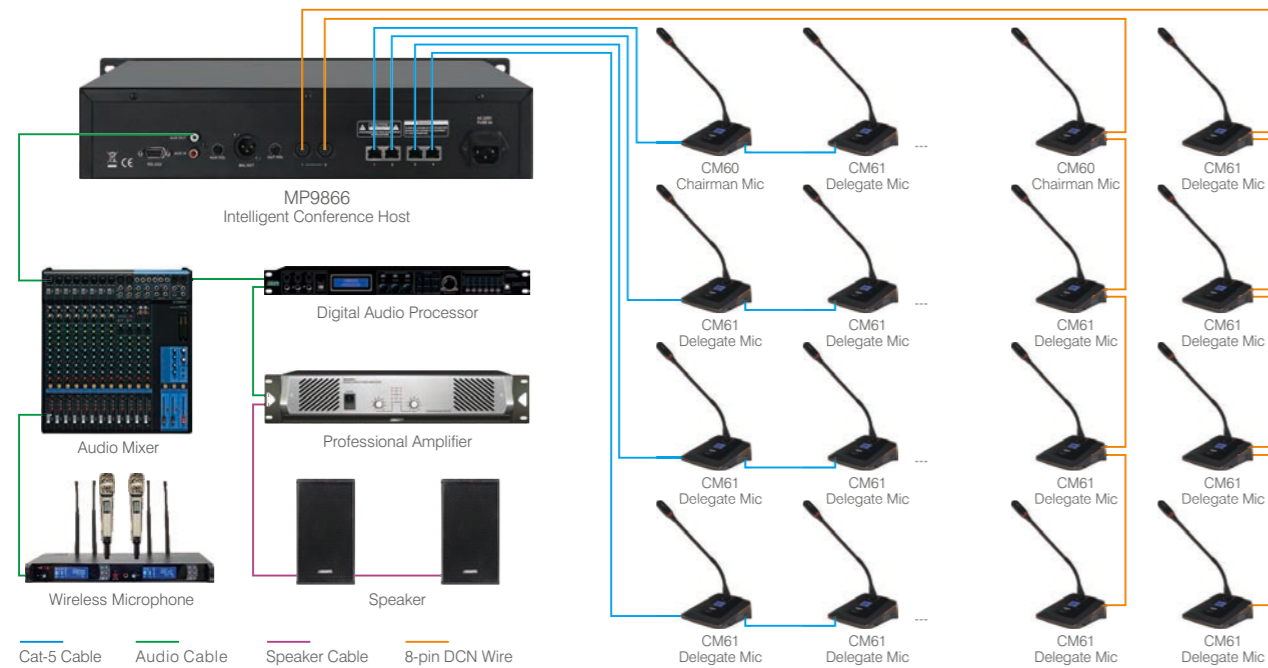

Static Consumption	8W	Freq. Response	50-16kHz
Most Consumption	65W	SNR	>65dB
Output Power	≤36W/18V/CH	Distortion	<0.5%
Line Out	100Ω unbalanced	Dimension	484x365x88mm
Input Sensitivity	≤110mV	Net Weight	6.5kg

D6686 Immersive Audio Processor



- Built-in high-performance DSP patented immersive acoustic algorithm
- The product has 16 XLR inputs and 16 XLR outputs
- It has the function of positioning and adjusting 16 input signals at the same time
- Software operations take effect in real time, improving ease of operation
- The user interface can adjust the sound source trajectory, preset trajectory and volume adjustment
- Suitable for all kinds of conference rooms, museums

The diagram compares two sound field scenarios. The top part, labeled 'Disadvantages of Traditional Sound System', shows sound waves from a 'Chairman' microphone spreading uniformly in all directions, indicated by red arrows and a red circle. The bottom part, labeled 'Conference Sound Reinforcement Application', shows the same setup but with sound waves directed precisely towards the audience, also indicated by red arrows and a red circle. A large blue sphere in the background represents the sound field control.

Sound Follows the Movements, Voice Points the Way.

The system uses the three-dimensional layout processing algorithm of DSPPA. Through complex data processing, it achieves high-precision sound source localization and spatial sound field control, **which enables the audience to clearly identify the speaker's direction through the sound system**, fully facilitating a complete immersion in the event's atmosphere.

Patented immersive panoramic acoustic algorithm

Immersive Audio System

Speaker Layout

The speaker layout can be installed according to local conditions on the sound reinforcement site, with no specific requirements for speaker placement.

Different speaker layouts can be quickly optimized for the best positioning and sound effects, enhancing installation and setup efficiency.

Immersive Audio Processor

Exclusive Audio Processing Algorithm.

Combining speaker placement plans with customer needs, the algorithm provides unique parameters and processing solutions.

Independent tracking and positioning for up to **16 individuals**
Project Reference | Device Space Modeling



Web control

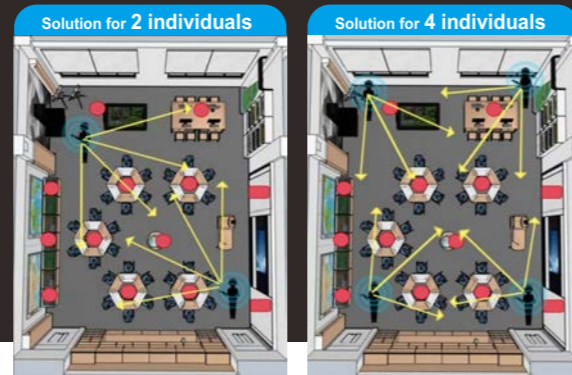

Control Line
Audio Cable
Speaker Cable
Data Cable

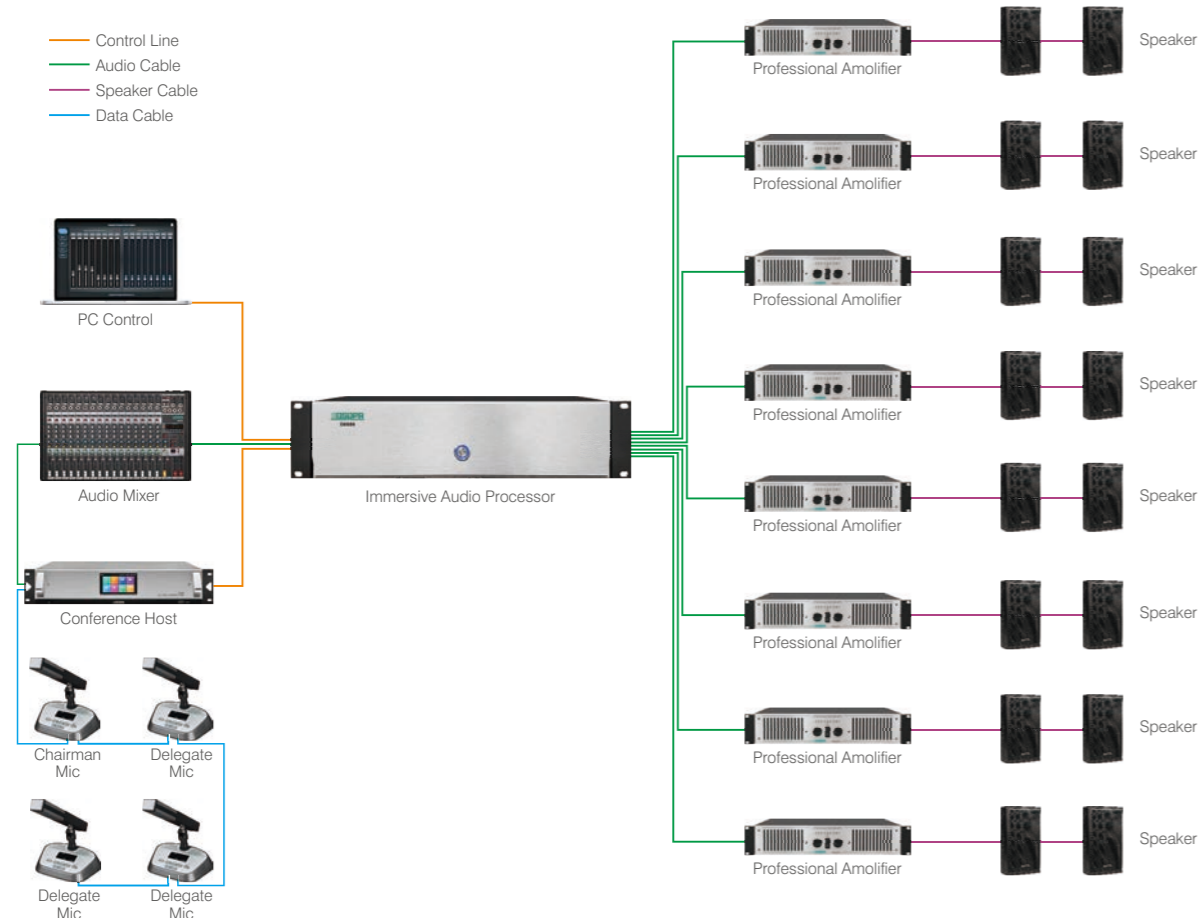

D73 Series 5G WiFi Conference System

D7301 5G WiFi Wireless Transmitter can transmit 6 video signals and control signals simultaneously by adopting 48K, 16-bit uncompressed audio transmission technology. Based on one technology, it brings to customers Wi-Fi wireless discussion, check-in, voting, simultaneous transmission, intelligent control, clock date display and other functions. Application: Conference Hall, Training Room and Command Center, etc.

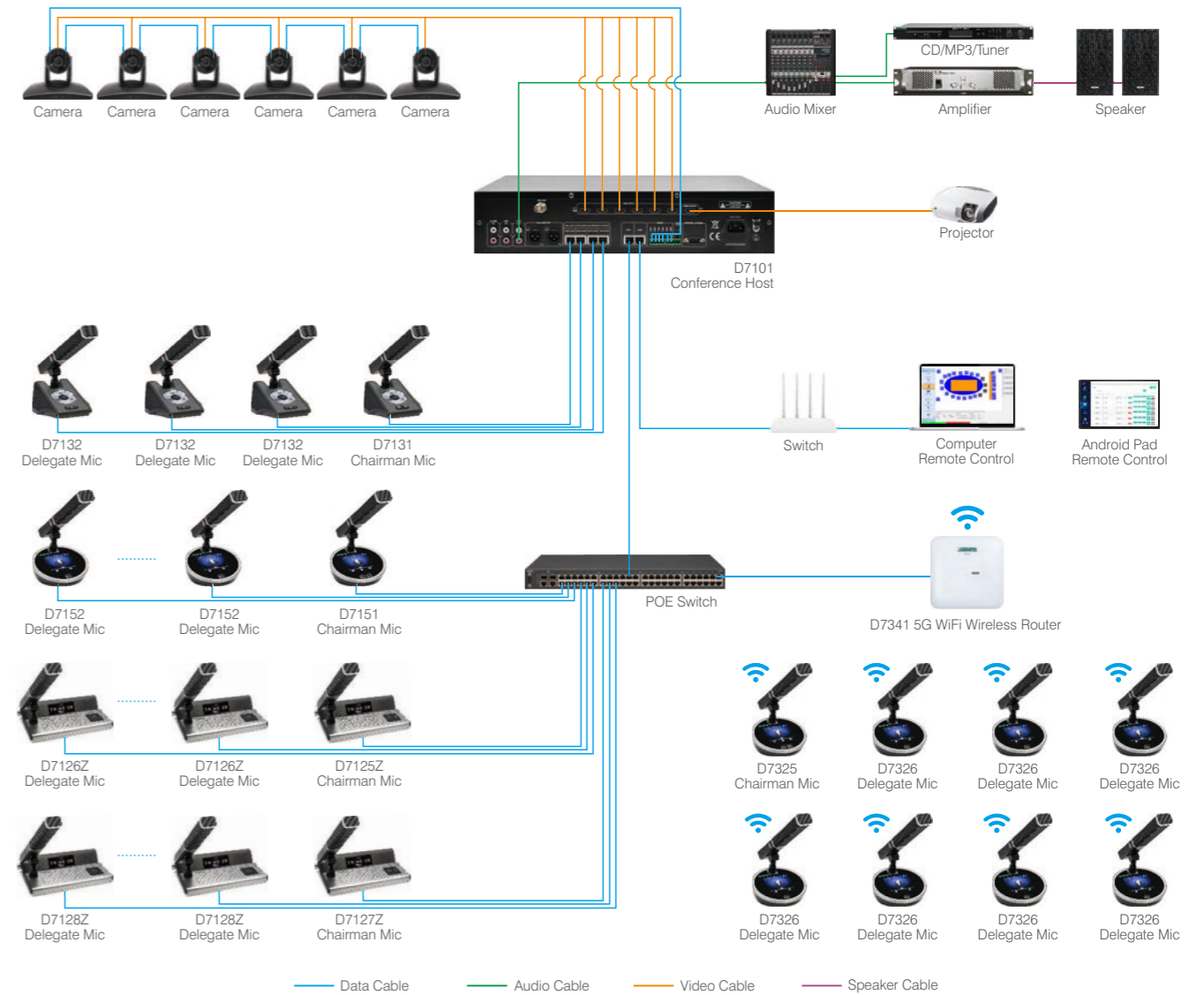

- 4.3 inch touch screen
- 5G WiFi encrypted technology
- Speech, Sign-in, Voting, Statistic, System setting
- Built-in DSP processor and EQ adjustment
- Support automatic camera tracking function
- Max 300pcs wireless microphone
- Max 4096pcs conference microphone
- Support mobile pad remote control via internet

Application: Conference room, Court, Lecture hall, International Center, Stadium, Training room, etc.

D7200

5G WiFi Conference System Software (PC)

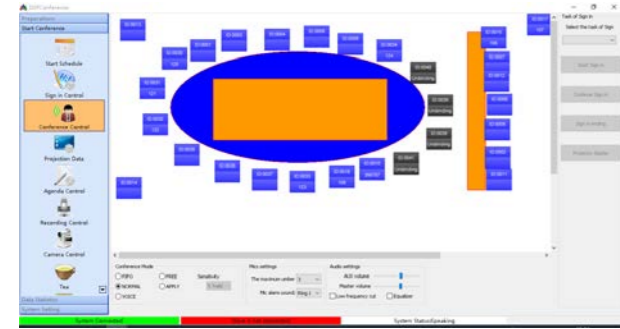

- Conference order management
- Conference reservation
- Voting initiation
- Voting result counting
- Conference unit setting

D7200M

5G WiFi Conference System Mobile Software (Web)

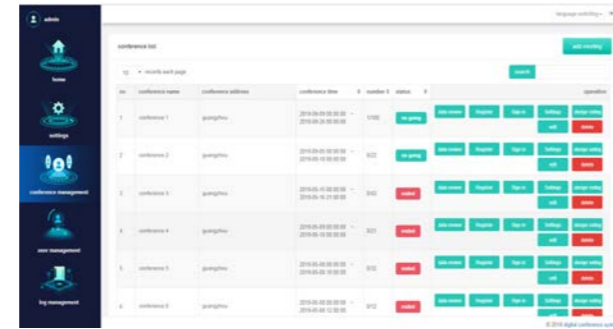

- Camera tracking setting
- Check-in function
- Recording control
- Real-time display
- Password access

D7321 / D7322 / D7323 / D7324

5G WiFi Conference Microphone with Voting Function (D7321/D7322)



D7321
Chairman Mic

D7322
Delegate Mic



D7323
Chairman Mic

D7324
Delegate Mic



(Customized)

- 2.42 inch OLED screen, display voting results, volume, microphone status, power state, WiFi status, etc.
- Built-in rechargeable lithium battery, battery capacity 10000mAh, continuously speaking for more than 8 hours
- 128-bit AES digital encryption technology, WAP / WAP2 security connection, MAC address filtering, hidden SSID, prevent eavesdropping and unauthorized access
- Low-delay technology, minimum delay is less than 20ms

D7325 / D7326

5G WiFi Conference Microphone with Voting Function



D7325
Chairman Mic

D7326
Delegate Mic



(Customized)

- 4-inch OLED screen, display voting results, volume, microphone status, power state, WiFi status, etc.
- Built-in rechargeable lithium battery, battery capacity 10000mAh, continuously speaking for more than 8 hours
- 128-bit AES digital encryption technology, WAP / WAP2 security connection, MAC address filtering, hidden SSID, prevent eavesdropping and unauthorized access
- High directive microphone, with windproof cover, with LED indicator ring, speech for red, wait for green
- D7325 is chairman microphone, with first priority button
- Using a low-delay technology, minimum delay is less than 20ms
- 48K sampling rate, digital control, high quality of audio transmission

D7341

5G WiFi Wireless Router



- Adopt WPA / WPA2 digital encryption technology
- Compliance with IEEE802.11ac Wave-2/A/B/g/N wireless standard
- Multiple frequency point selection from UHF, 2.4GHz and 5GHz
- With two RJ45 interfaces
- External four-antenna design
- Signal coverage in complex environments is radius of 25 meters, which can reach a radius of 30 meters normally
- Maximum power consumption: 15W

D7301
5G WiFi Wireless Transmitter



- Adopt WPA / WPA2 digital encryption technology
- Compliance with IEEE802.11ac Wave-2/A/B/g/N wireless standard
- Multiple frequency point selection from UHF, 2.4GHz and 5GHz
- With two RJ45 interfaces
- External five-antenna design
- Signal coverage in complex environments is radius of 25 meters, which can reach a radius of 30 meters normally
- Maximum power consumption: 25W

D7331
5G WiFi Conference Microphone Charger



- Support fast charge, fast charge USB port output 9V, slow charge output 5V
- Lithium battery of the microphone is 1000mAh, charge time is less than 3.5 hours
- It can charge up to 10pcs microphone at the same time
- Comply with QC3.0 protocol
- Max power consumption 200W

D6850 2.4G Wireless Microphone System

The 2.4G Wireless Digital Conference System is a fully digital conference system specifically designed to integrate wireless discussion, camera tracking, and other functions. A single conference host can connect up to 255 wireless digital conference units. The system operates in the ISM frequency band using 2.4G full digital frequency-hopping (DSSS) modulation communication technology, enabling seamless coexistence with WiFi and featuring exceptional anti-interference capabilities.

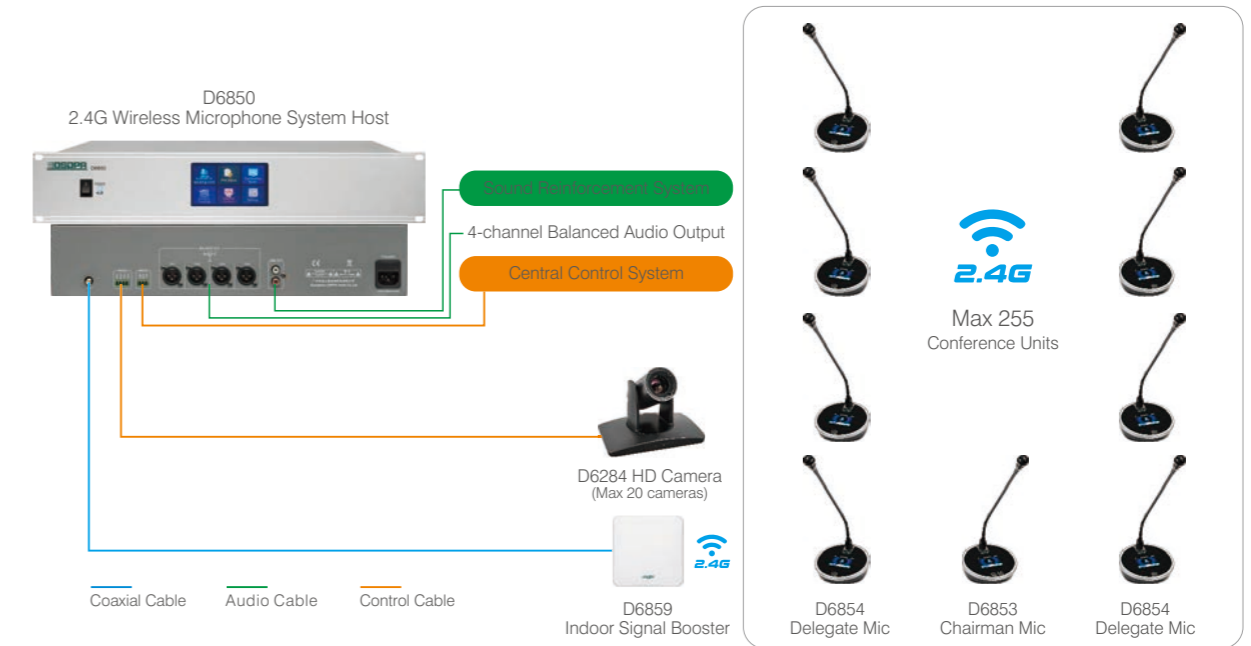

D6850
2.4G Wireless Microphone System Host



- With 4.3-inch touch screen
- 2.4G universal wireless control and transmission technology
- Full digital audio processing technology with an audio sampling rate of 48kHz
- One system can support up to 255 wireless microphones
- 3 conference modes: FIFO, Normal, Chairman mode
- Includes a one-button shutdown function to turn off all units
- Equipped with one RS232 interface for seamless integration with central control systems
- Displays real-time information on channels, ID addresses, and battery levels of the units
- Includes one RS422 interface for centralized camera control
- Supports speech timing and countdown reminders

D6851 / D6852 / D6853 / D6854
2.4G Wireless Microphone



- Conference unit with pure speech function
- Each conference unit has a unique ID number
- Equipped with a microphone on/off button, the chairman unit has a chairman priority button
- 2.8-inch TFT color screen displaying unit ID, signal strength, battery level, time-limited speech, etc.
- Microphone rods can be detached or replaced, with options for gooseneck or square mic rod
- Adjustable microphone volume
- Strong anti-interference ability against mobile phone signals
- Simplified Chinese and English bilingual display for unit information
- High-fidelity lossless audio transmission technology, with 48kHz audio sampling rate
- Includes encryption protection to prevent eavesdropping and unauthorized access, ensuring the confidentiality of meetings
- Supports automatic camera tracking when used with host settings and paired with a camera
- TYPE-C charging interface, supporting 18W fast charging

D6859
Indoor Signal Booster



- Uses a 14dBi directional high-gain planar antenna in the 2.4-2.5G frequency band
- Built-in 2.4G ultra-low power wireless module with a 48K digital audio sampling rate
- Utilizes 2.4G all-digital frequency-hopping modulation communication technology
- Includes a powerful built-in wireless audio transmission protocol
- Built-in digital circuitry significantly amplifies the 2.4G wireless signal
- Connects directly to the host without the need for an external power supply
- Radiation range of up to 40 meters in a straight line

D58 Series
Multi-channel Wireless True Diversity Microphone System
(Lithium battery version is available)



D5815
2 Channels Wireless Microphone System Receiver



- 2 channels True Diversity microphone system, connect with 2 microphones
- PLL digital automatic communication function
- Adopt IR frequency pairing
- With screen to display working status, like frequency, channel, squelch and electrical level
- With volume control for each channel
- With XLR interface for output
- Frequency range: 632-661.25MHz
- Working distance up to 300 meters

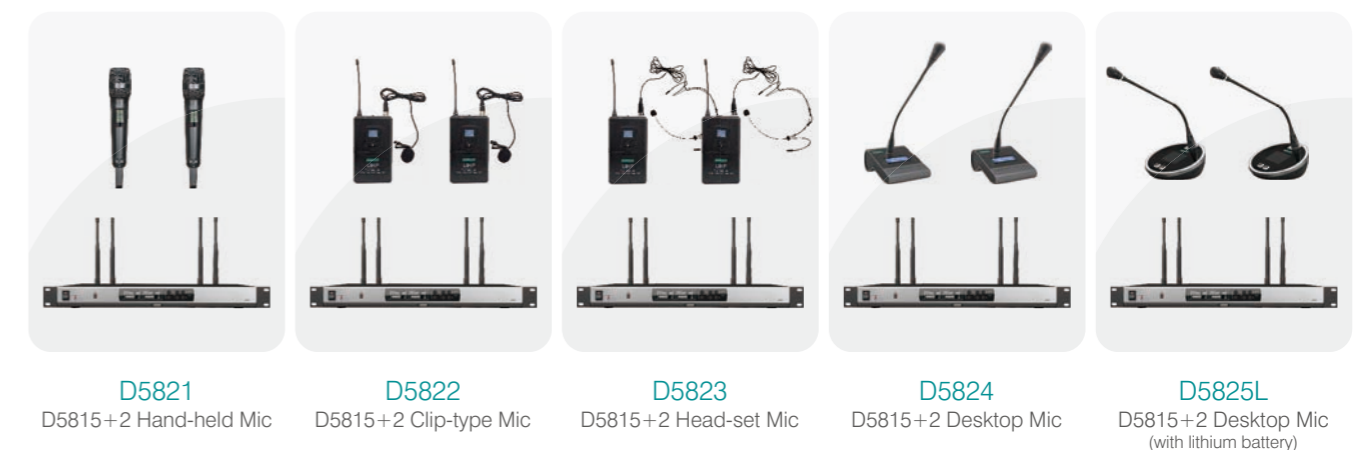

D5816 4 Channels Wireless Microphone System Receiver



- 4 channels True Diversity microphone system, connect with 4 microphones
- PLL digital automatic communication function
- Adopt IR frequency pairing
- With screen to display working status, like frequency, channel, squelch and electrical level
- With volume control for each channel
- With XLR interface for output
- Frequency range: 632-695.25MHz
- Working distance up to 200 meters

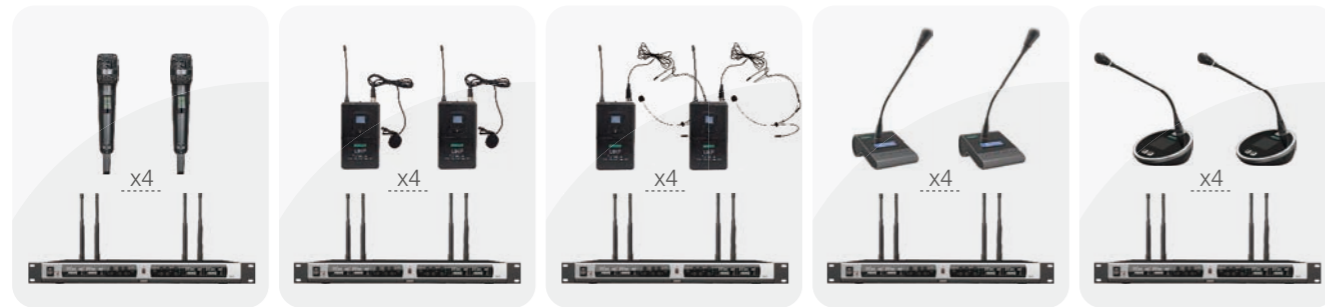

D5841 D5816+4 Hand-held Mic
D5842 D5816+4 Clip-type Mic
D5843 D5816+4 Head-set Mic
D5844 D5816+4 Desktop Mic
D5845L D5816+4 Desktop Mic (with lithium battery)

D5817 8 Channels Wireless Microphone System Receiver



- 8 channels True Diversity microphone system, connect with 8 microphones
- PLL digital automatic communication function
- Adopt IR frequency pairing
- With screen to display working status, like frequency, channel, squelch and electrical level
- With volume control for each channel
- With XLR interface for output
- Frequency range: 632-695.25MHz
- Working distance up to 200 meters



D5881 D5817+8 Hand-held Mic
D5882 D5817+8 Clip-type Mic
D5883 D5817+8 Head-set Mic
D5884 D5817+8 Desktop Mic
D5885L D5817+8 Desktop Mic (with lithium battery)

D5828C / D5836C 8/16 Channels Antenna Signal Amplification



D5828C



D5836C

D58C Directive Antenna

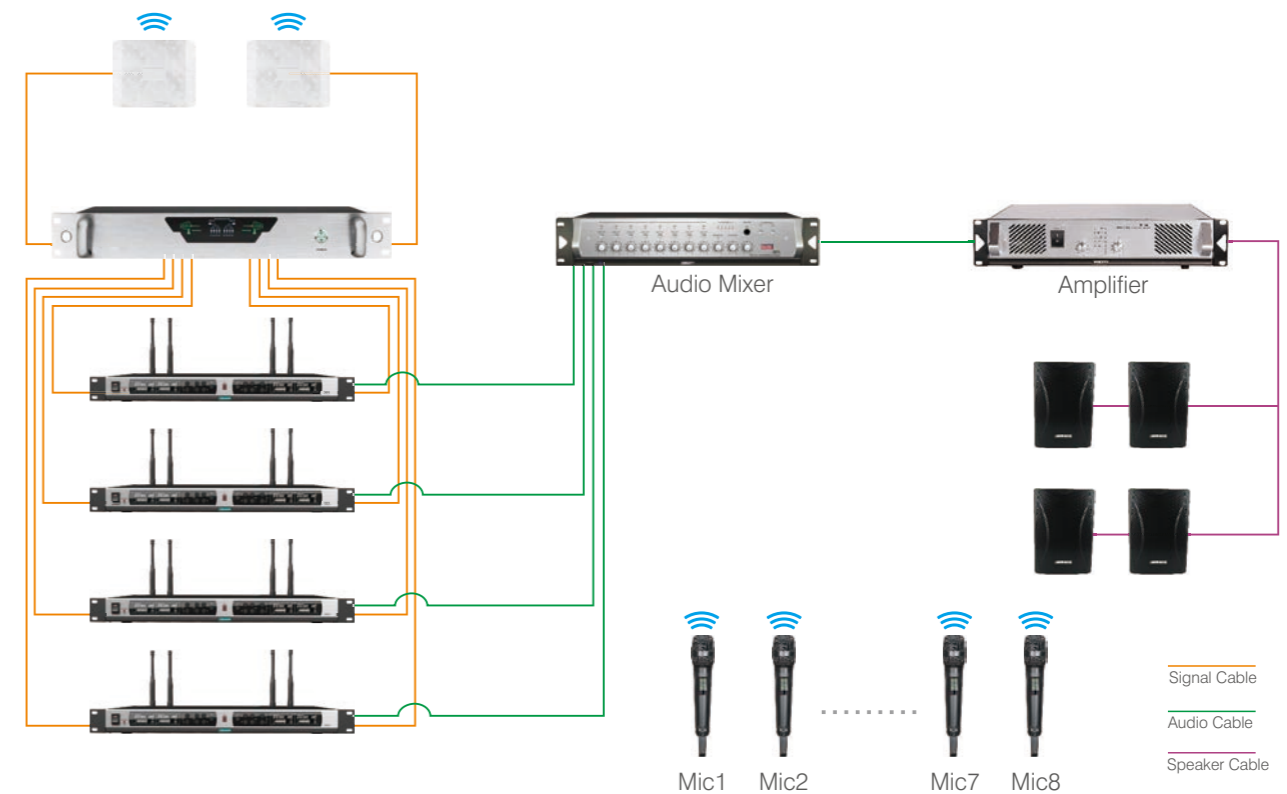

Paperless Conference System Solution

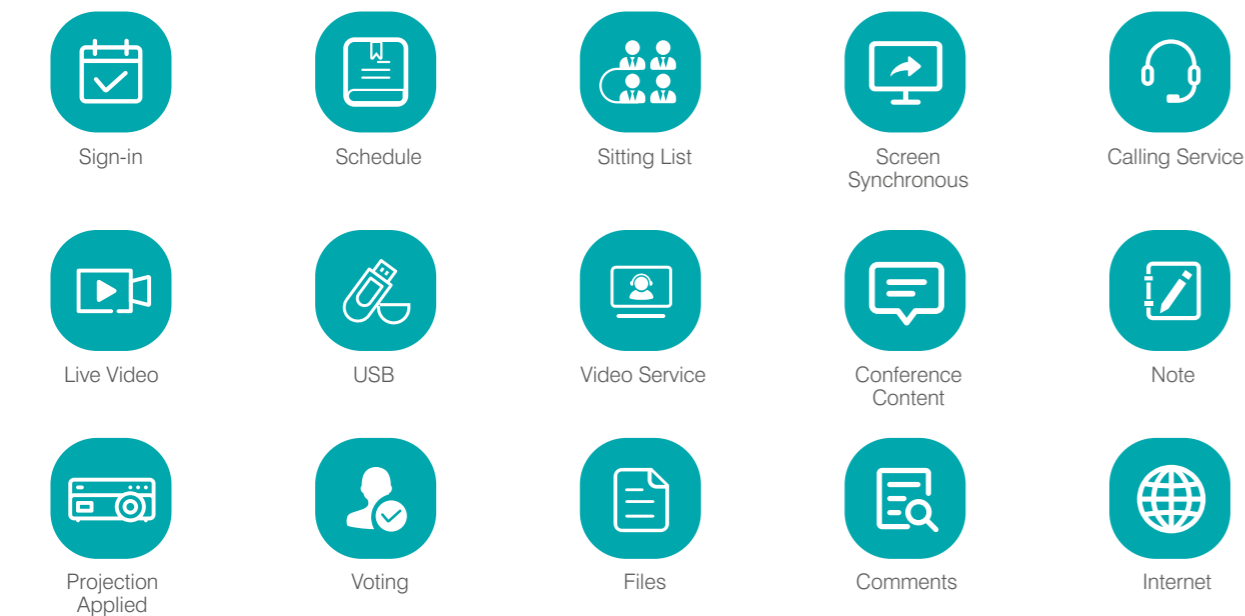
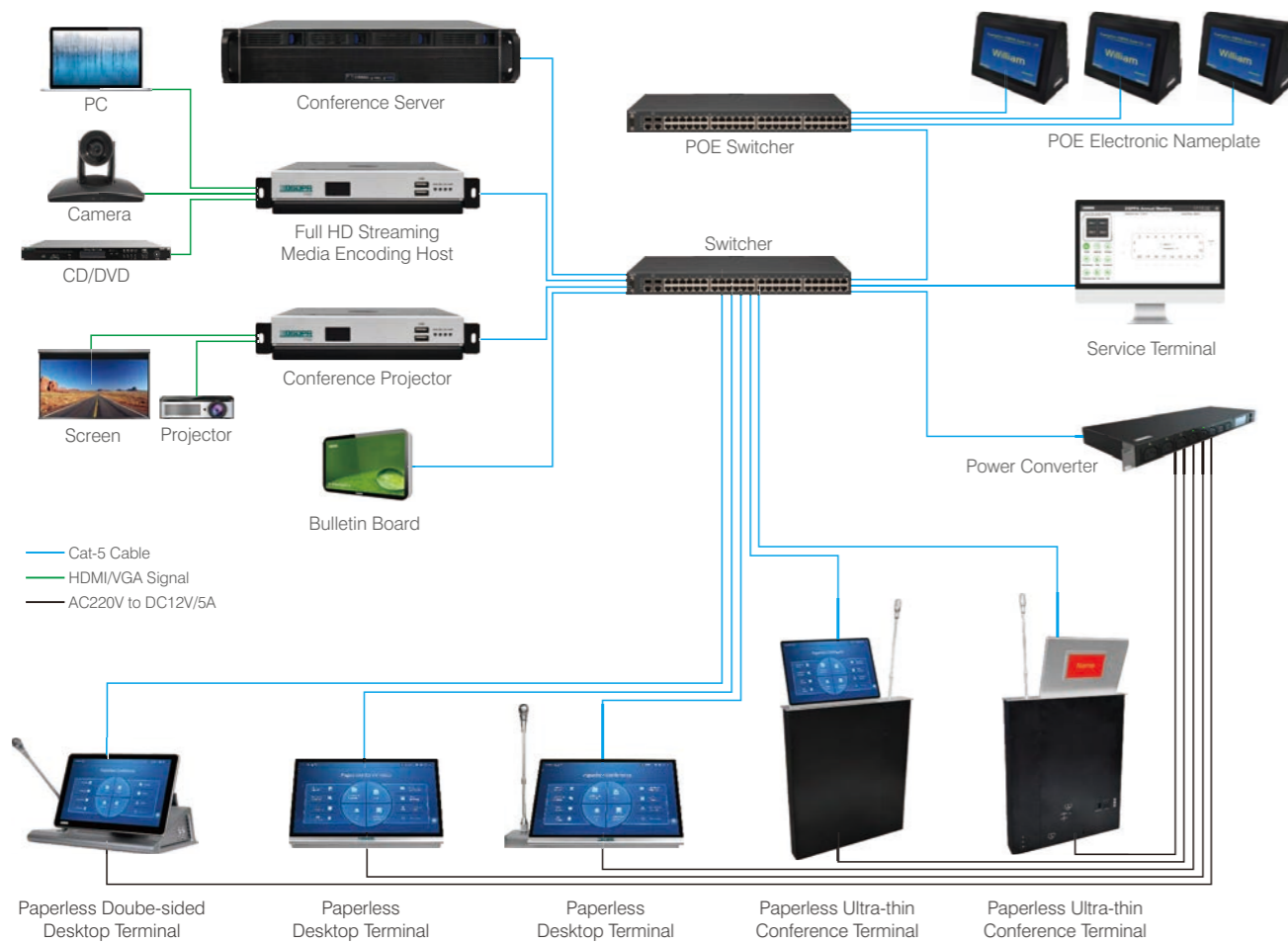

D7600

Paperless Conference System Document Server



- Manage the multimedia intelligent paperless system effectively for one or more conference rooms
- Improves the interactive transmission, management and information backup of multimedia paperless system
- With paperless conference system software, processing up to 128 terminal's document
- Supports the functions of signing in, voting, document projection, document matching screen and document annotation of the conference terminals
- Conference process files can be stored in the intelligent paperless conference server in real time

D7600P

Paperless Conference System Software (PC)

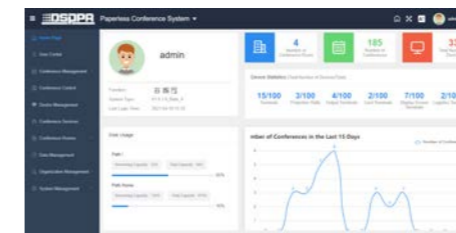

- Based on CS structure+BS application, resolution ratio 1920x1080
- Functions supported: Name import, Conference attendance, call service, Conference and participants information viewing, Conference minutes (Word format), Voting, Internet access, File distribution and so on
- Support PC desktop sharing and external PC connection
- Support remote video conference and HD video playback
- Support management of multiple conferences, one conference for multiple meeting rooms or individual
- Conference in each room, support preset of conference time
- Support central control of lifting devices and hosting function (play the video or open files simultaneously for all devices)
- Support UI interface customization
- Support playback of 4 videos simultaneously

D7600A

Paperless Conference System Software (Android)

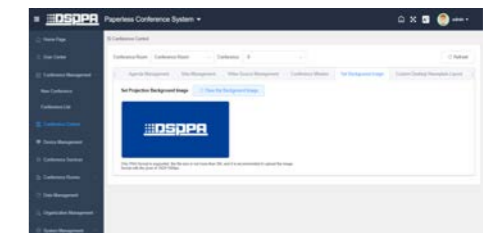

- Support terminal management, display the device online status, IP address
- Support for sorting, adding or decreasing, single-column display
- Support control terminal lifting
- Support meeting management function: increase, modify, delete meetings, control the beginning and end of the conference
- Support voting: You can import the voting content through the Excel, then view the voting results, and export the results to Excel, set the vote for real name / anonymity
- Support meeting sign-in function: You can see the sign-in situation of the participants in real time
- Support large-screen broadcast function: you can broadcast video on the big screen, suspend, restore, retreat, initiate a big screen and end the big screen
- Support call service: Support voice broadcast, classify the requesting request with unopened requests

D7513TZ / D7513TzM

13.3" Paperless Double-sided Desktop Terminal
(D7513TzM with Microphone)



- Paperless two-sided desktop terminal, IP screen with clear and bright display
- Main screen: 13.3 inch, Back screen: 7 inch, 16:9
- Screen ratio: 1920x1080, back screen ratio: 1024x590
- D7513TzM with Microphone
- Rated power: 60W
- Output interface: VGA, HDMI, Audio, RJ45
- Capacitive touch screen, support handwriting on the screen
- Power supply DC24V
- Support background central control (restart, power-off)
- Exquisite processing technique, beautiful and comfortable to use
- Work through Ethernet, easy to connect, adjust and maintain

D7615PDX / D7615PDTX

15.6" Full HD Touch Screen Desktop Conference Terminal
(D7615PDTX with Microphone)



- With waterproof driver inside
- Support 1920x1080 resolution
- With 15.6" Touch screen
- With 10.1" nameplate
- D7615PDTX with Microphone
- Built in memory 4GB
- SATA: 128GB SSD

D7615P / D7617P / D7618P

15.6" / 17.3" / 18.5" Full HD
Condenser Ultra-thin Conference Terminal
with Lifting Monitor



D7615PT / D7617PT / D7618PT

15.6" / 17.3" / 18.5" Full HD
Condenser Ultra-thin Conference Terminal
with Lifting Monitor & Microphone



D7615PZ / D7617PZ / D7618PZ

15.6" / 17.3" / 18.5" Full HD
Condenser Ultra-thin Conference Terminal
with Lifting Monitor & Nameplate



D7615PX / D7617PX / D7618PX

15.6" / 17.3" / 18.5" Full HD
Condenser Ultra-thin Conference Terminal
with Lifting Monitor & Nameplate



D7615PTZ / D7617PTZ / D7618PTZ
15.6" / 17.3" / 18.5" Full HD
Condenser Ultra-thin Conference Terminal
with Lifting Monitor & Mic & Nameplate



D7615PTX / D7617PTX / D7618PTX
15.6" / 17.3" / 18.5" Full HD
Condenser Ultra-thin Conference Terminal
with Lifting Monitor & Mic & Nameplate



D7616C
15.6" Ultra-thin Lifting
Monitor Terminal



D7616BC
15.6" Ultra-thin Lifting
Monitor Terminal
with Nameplate



D7616MC
15.6" Ultra-thin Lifting
Monitor Terminal
with Microphone



D7621P / D7621PT
21" Full HD Condenser Ultra-thin
Conference Terminal



D7621P

D7621PT

D7621PX / D7621PTX
21" Full HD Condenser Ultra-thin
Conference Terminal
with Lifting Monitor & Nameplate



D7621PX

D7621PTX

D7616BMC
15.6" Ultra-thin Lifting
Monitor Terminal
with Mic & Nameplate



D7616HC
15.6" Ultra-thin Lifting
Monitor Terminal
with Built-in Mini Host



D7616BHC
15.6" Ultra-thin Lifting
Monitor Terminal
with Built-in Mini Host
& Nameplate



D7632R / D7632Z Conference System Projection Switcher



- Support multiple user projection applications
- Support up to 4pcs 1920x1080P screen, D7632Z support up to 2pcs 2K screen
- Based on Linux, embedded design, low power consumption, high efficiency
- Audio interface: 1 stereo audio input, 1 stereo audio output, Phoenix socket
- Output resolution: 1920x1080, D7632Z compatibility with 4K
- 4 indicator lights, 0.96" OLED screen
- Maximum power consumption: 8W (DC12V)

D7602 / D7602E Intelligent Network Extender



- 24 ports 10/100/1000Mbps network switch
- Support web management
- Support IEEE802.3x data control
- Working temperature: 0-40°
- With lightning protection
- Power input AC100-240V/50-60Hz
- Power consumption 15W
- D7602E with POE power supply function

D7609D Conference Control Terminal



- Supports network command control
- Support local button control 4 strong current relay switch
- Support indicator to indicate the switching status of the strong current relay
- Supports serial port output and forwarding data
- Supports RS-232 and RS-485 output
- Supports I/O interface control
- Power supply: DC12V power supply

D7633 Full HD Streaming Media Encoding Host



- With HDMI video signal input
- With the master chip for video compression
- Support audio and video interaction between different meeting rooms

D7634 Full HD Conference Recording Server



- Support 6 HD-SDI HD inputs, 2 HDMI inputs, 2 VGA inputs, 1 HDMI output, 1 VGA output, 2 USB ports (the above ports do not support transfer), HD video and computer resolution of 1920*1080, and downward compatibility
- Support local hard disk video file playback, USB video file playback and remote RTSP video stream playback and recording
- Support 12 different split-screen layout modes, and support user-defined split-screen layout mode settings
- Support automatic trigger switching of the PPT signal of the teaching computer, without installing any auxiliary software and plug-ins in the computer

D7635II Intelligent Conference Receiving Terminal



- This system provides service call function
- Product structure: Aluminum alloy frame + tempered glass
- Operating system: Android 10
- Signal port: 1xR45, 1xOTG
- Screen size: 10 inches, 1280 x 800P resolution
- Power supply: DC24V

D7635A Intelligent Conference Android Software



- During the meeting, the system provides service call function, which is convenient for each participant to need during the meeting
- Supports Android 5.0 or later
- Support tea, paper, pen, calculator, service personnel, cleaning call service real-time reminder
- Support to locate the caller's seat, precise and fine service
- Classifies by processed and unprocessed services, and classifies by service types

TB8511 Mini Conference Host



- Supports switching client interfaces to different theme styles
- Enables quick access to meeting chat modules, materials, and unread message notifications
- Supports dual-screen display
- Allows viewing of current meeting participants and their seating arrangements
- Displays meeting agendas for easy navigation
- Enables participants to quickly call for common services

D7612Q / D7612Q2 / D7612Q3 Mini Conference Host



D7612Q

- CPU: Intel Core i5 8th generation
- RAM: DDR3 4GB
- Hard disk capacity: 128GB SSD
- Network Card: 1x gigabit network card, RJ45 Interface

D7612Q2

- CPU: Intel Core i5 8th generation
- RAM: DDR3 8GB
- Hard disk capacity: 256GB SSD
- Network Card: 1x gigabit network card, RJ45 Interface

D7612Q3

- CPU: Intel Core i7 8th generation
- RAM: DDR3 8GB
- Hard disk capacity: 512GB SSD
- Network Card: 1x gigabit network card, RJ45 Interface

D7616Q Mini Conference Host



- CPU: Intel Core i5 4590 3.3G
- RAM: DDR3 8GB
- Hard disk capacity: 128GB SSD
- Interface: RJ45x1, HDMIx1, VGAx1, USB3.0x2, USB2.0x2

D7022II / D7022MIC Dual Screen Conference Electronic Nameplate



D7022II



D7022MIC

- Conference System electronic nameplate
- Dual 7" LCD touch screen, graphic interface, easy to use
- Clear display of conventioneer's information like company, position, name, etc.
- Support normal office documents as Word, Excel, PDF, etc.
- Support service call function and voting function
- Support central control and file sharing from the host via software D8300
- D7022MIC with microphone base, can be installed with microphone

Screen	7" 800x480 pix (dual screen)
RAM	512M
Working Platform	Android
Input Interface	DCx1, RJ45x1
Communication	Cable or Wi-Fi
Power Supply for Adapter	AC 110-240V
Power Supply for Panel	DC 5V/3A (IEEE 802.3af)

D7685

10.85 Inch Dual Display E-Ink Screen Meeting Nameplate



- Screen Size: 10.85 inch (Dual display)
- Communication Protocol: 2.4G Protocol/Bluetooth V5.0
- Operating Voltage: 3.7V
- Transmission distance: 30 meters
- Resolution: 1360x480px
- Display type: Electronic Ink Screen/E-Paper/EPD
- Support color: Sliver
- Viewing angle: about 180°
- Battery life: 3-5 year
- Support Platform: Android and IOS

D7676

10.85 Inch Dual E-Ink Screen Meeting Nameplate with Photovoltaic Charging

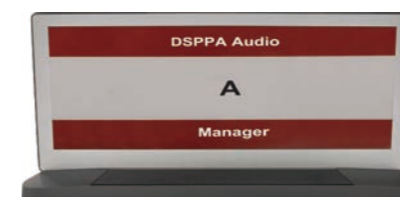

- Screen Size: 10.85 inch x2
- Resolution: 1360*480px 133DPI
- Viewing angle: 180°
- Battery capacity: 230mAh, charging via photovoltaic panels
- Working mode: NFC/Bluetooth/PC
- Transmission distance: 15 meters
- Support color: Black/White/Red
- Support system: Android 7.0 above, iOS 9.0 above, HarmonyOS

D7673

7.3 Inch Dual Electronic Ink Screen Meeting Nameplate



- Screen Size: 7.3 inch x2
- Resolution: 800*480px 125DPI
- Viewing angle: 180°
- Battery capacity: 1800mAh, rechargeable
- Battery life: 8 month
- Working frequency: 2.4G
- Transmission distance: 15 meters
- Support color: Black/White/Red/Yellow/Blue/Green
- Support format: Text, Barcode, QR Code, Image
- Material: ABS+PC

D7675

7.5 Inch Dual Electronic Ink Screen Meeting Nameplate



- Screen Size: 7.5 inch x2
- Resolution: 800*480px 125DPI
- Viewing angle: 180°
- Battery capacity: 1800mAh, rechargeable
- Battery life: 8 month
- Working frequency: 2.4G
- Transmission distance: 15 meters
- Support color: Black/White/Red
- Support format: Text, Barcode, QR Code, Image
- Material: ABS+PC

D7673B

Bluetooth Gateway



- Transmission distance: radius of 15 meters
- Frequency band: 2.4G/Bluetooth
- Antenna: Built-in Antenna
- Transmit Power: 20dBm (MAX)
- Power Supply: 5V/2A, TYPE-C Power Supply
- Power Consumption: Less than 2.0W

2K Audiovisual Matrix System

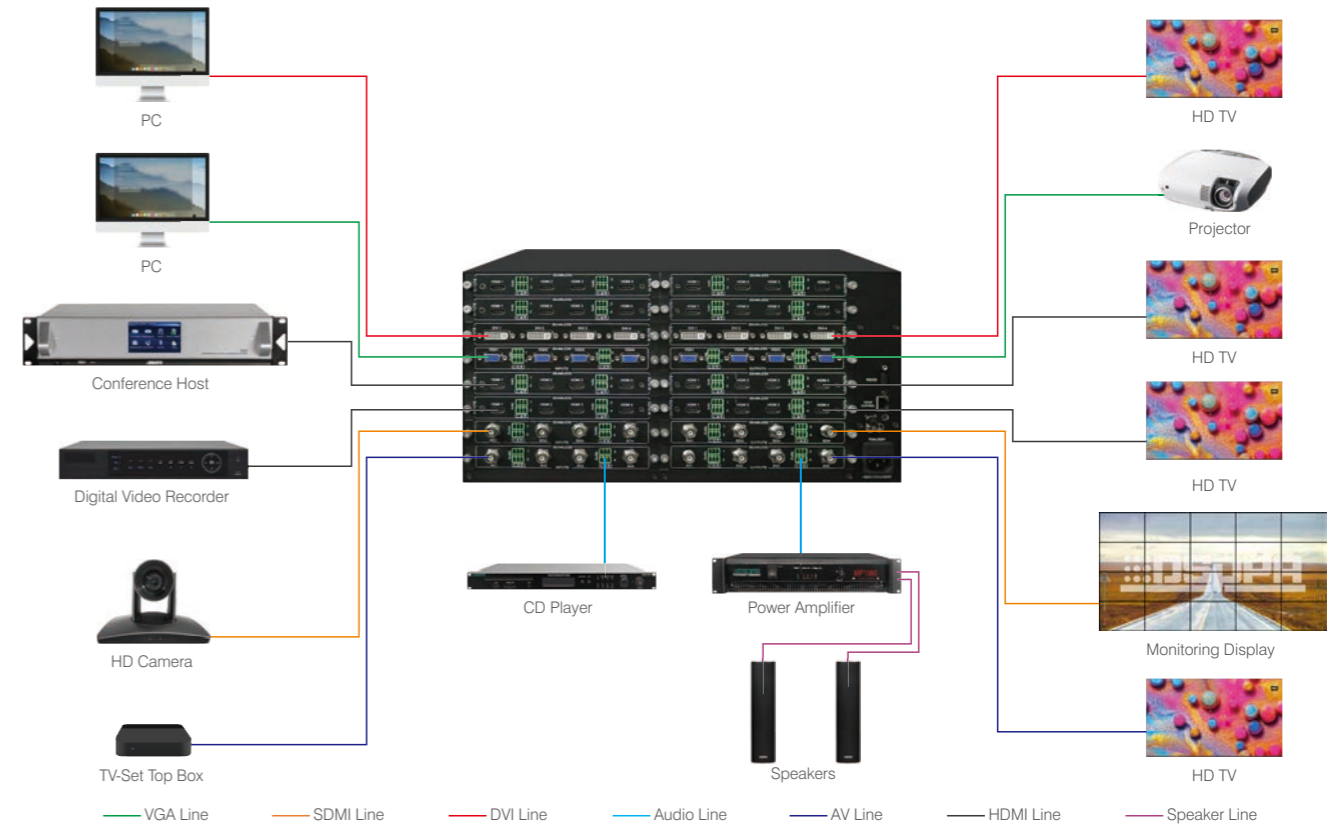

- Plug-in box structure. Support input cards: AV, VGA, DVI, HDMI, SDI; support output cards: AV, VGA, DVI, HDMI, SDI, card structure, easy to expand or replace
- Support seamless switching; full color processing without any color loss; support frame rate adaptation, built-in image scaling engine, input scaling to any output resolution conversion
- Inputs such as AV and VGA support analog audio input mixing; DVI, HDMI, and SDI inputs support analog audio/digital audio selection mixing; mixed signals support embedded audio output (HDMI, SDI, DVI)
- Support various input resolutions: 800*600, 1024*768, 1280*720, 1280*768, 1280*800, 1280*1024, 1360*768, 1366*768, 1440*900, 1400*1050, 1600*900, 1680*1050, 1920*1080@60Hz, 1920*1080@50Hz, 1920*1080@30Hz, 1920*1080@25Hz, 1920*1200
- Support switching and memory function, remote network control matrix switching, RS232 switching, panel switching function; power-off memory function and live memory function: with power-off protection function; and can save and call 10 switching scenes
- Low power consumption, continuous 7*24 hours without abnormalities
- Support 3D, HDMI 1.4 (Partial), HDCP, and DVI 1.0 protocols. Support high color depth and a maximum speed rate of 3.25Gbps; support one RJ45 network port, one RS-232 communication interface



Software

D6108 / D6116 / D6132

8/16/32 Channels Digital Modular Seamless Matrix Switcher



D6108



D6116



D6132

- Support 8-channel, 16-channel, 32-channel signal inputs and outputs
- Intelligent matrix system for audio and video signal switching, compatible with different audio signal input/output signal cards
- Signal cards matched include: HDMI, DVI, VGA, SDI, AV seamless input / output signal cards
- Support multiple signal input and output cross matrix switching, providing independent video signal and audio input and output terminals
- The audio and video signals of each video signal are transmitted separately and switched separately to minimize the attenuation of signal transmission. The image and sound signals can be output with high fidelity and can be matched with the input and output signal cards randomly
- Support power-off protection, power-off memory, audio and video synchronization or separate switching
- With RS232 communication interface and TCP/IP (optional function) control, it can be easily used with personal computer, remote control system or various remote control devices
- Mainly used in radio and television engineering, multimedia conference halls, large-screen display engineering, television teaching, command and control centers and other occasions

	Input Slot	Output Slot	Input Size	Output Size	Channel for Each Card	Dimension	Power
D6108	2	2	4 channels	4 channels	4 channels	2U	Maximum 100W
D6116	4	4	16 channels	16 channels	16 channels	3U	Maximum 200W
D6132	8	8	32 channels	32 channels	32 channels	5U	Maximum 350W



D6104VR
4 Channels VGA Digital Input Card



D6104VC
4 Channels VGA Digital Output Card



D6104HR
4 Channels HDMI Digital Input Card



D6104HC
4 Channels HDMI Digital Output Card



D6104SR
4 Channels SDI Digital Input Card



D6104SC
4 Channels SDI Digital Output Card



D6104AR
4 Channels AV Digital Input Card



D6104AC
4 Channels AV Digital Output Card



D6104DR
4 Channels DVI Digital Input Card



D6104DC
4 Channels DVI Digital Output Card

D6900 4K HD Visualization Distributed System

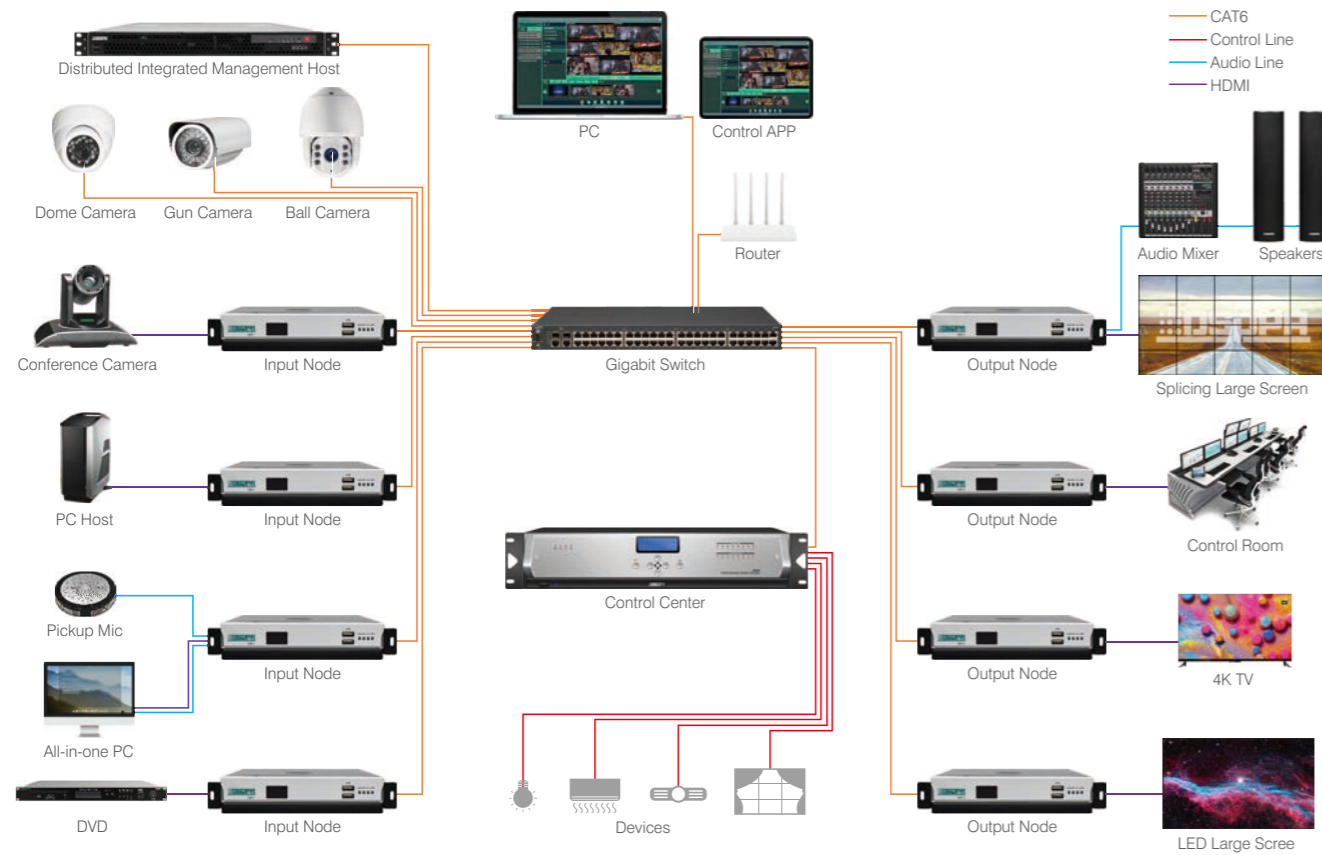

D6901 4K Distributed System PC Software



- Support B/S, C/S architecture
- Support state monitoring of input and output nodes
- Supports real-time visual preview of signal sources
- Support any video signal source push to each terminal display
- Supports a maximum of 200 cameras
- Supports multi-level management
- Supports KVM agent management
- Support HD 1080P screen output display

D6902A / D6902I 4K Distributed System Android Software (Android/IOS)



- Supports real-time visual preview of signal sources
- Supports preview and echo of each terminal device
- Support signal classification and sorting function, can quickly select signal source for switching
- Support any video signal source push to each terminal display
- Support IP camera signal fetching, distribution and Display

D6900 4K Distributed System Management Host



- Support h265 code
- Support video channel channel management
- Support hierarchical forwarding of streaming media
- You can assign different channel permissions based on different user roles
- Seamless integration with input/output nodes
- Support remote upgrade and remote maintenance
- Support 4K HD network video preview, storage and playback
- Support Smart265, H.265, H.264 front-end adaptive access
- Support IPC parameter configuration

D6903 Distributed Camera Software



- Support all brand IP camera input and distribution
- Support the IP Camera meeting the onvif protocol into the distributed system, supporting 1080P resolution
- Support IP Camera automatic search
- Support storage server to store IP Camera images connected to distributed system

D6904 4K Distributed Power Terminal



- 7*24 hours long-term efficient and stable operation
- Power supply for 10 channels terminals
- Power interface: AC220V
- Maximum power consumption: 130W

D6905 / D6905S 4K Distributed HD Echo Terminal



- Using H.264/H.265 codec
- Supports 64 screen echo
- Video interface: 4K HDMI OUT
- 1 double channel audio input, 1 double channel audio output, phoenix socket
- 2 USB2.0 A interface, 1 USB3.0 interface
- 0.96 inch OLED screen, real-time display of information
- D6905S with 2 gigabit network interface

D6906D 4K Distributed Network Interface



- Support network command control
- Support RS-232, RS-485 output
- IO control: there are 4 IO interfaces inside the machine, which can also be used in the case of no central control
- Protocol compatibility: widely compatible with the current market of central control network protocols
- Each relay has a terminal with three connection points, with the function of normally open and normally closed

D6911E / D6911ES

4K HD Digital Distributed Input Terminal

D6911E: HDMI-1080P, RJ45
D6911ES: HDMI-1080P, RJ45, Fiber



D6911EC / D6911ED

4K HD Digital Distributed Input Terminal

D6911EC: HDMI-1080P, RJ45, KVM, Central Control
D6911ED: HDMI-1080P, RJ45, Fiber, Central Control



D6912E / D6912ES

4K HD Digital Distributed Input Terminal

D6912E: HDMI-1080P, RJ45
D6912ES: HDMI-1080P, RJ45, Central Control



D6912EC / D6912ED

4K HD Digital Distributed Input Terminal

D6912EC: HDMI-1080P, RJ45, Fiber
D6912ED: HDMI-1080P, RJ45, Fiber, Central Control



D6918 / D6918S

4K HD Digital Distributed Input/Output Terminal

D6918: HDMI-4K, RJ45, Input-Output Switching
D6918S: HDMI-4K, RJ45, Fiber, Input-Output Switching



D6918C / D6918D

4K HD Digital Distributed Input/Output Terminal

D6918C: HDMI-4K, RJ45, Central Control, KVM, Input-Output Switching
D6918D: HDMI-4K, RJ45, Fiber, Central Control, KVM, Input-Output Switching



D6919 / D6919S

4K HD Digital Distributed Input/Output Terminal

D6919: HDMI-4K, RJ45, Input-Output Switching
D6919S: HDMI-4K, RJ45, Fiber, Input-Output Switching



D6919C / D6919D

4K HD Digital Distributed Input/Output Terminal

D6919C: HDMI-4K, RJ45, Central Control, KVM, Input-Output Switching
D6919D: HDMI-4K, RJ45, Fiber, Central Control, KVM, Input-Output Switching



D6913 / D6913S

Distributed Digital HD Input Terminal

D6913: HDMI-4K, RJ45
D6913S: HDMI-4K, RJ45, Fiber



D6913C / D6913D

Distributed Digital HD Input Terminal

D6913C: HDMI-4K, RJ45, KVM
D6913D: HDMI-4K, RJ45, Fiber, KVM



D6914 / D6914S

4K HD Digital Distributed Output Terminal

D6914: HDMI-4K, RJ45
D6914S: HDMI-4K, RJ45, Fiber



D6914C / D6914D

4K HD Digital Distributed Output Terminal

D6914C: HDMI-4K, RJ45, KVM
D6914D: HDMI-4K, RJ45, Fiber, KVM



D6950 / D6951 / D6952 / D6953

2K HD Digital Distributed Output Terminal

D6950: 4-channel HDMI output
D6951: 8-channel HDMI output
D6952: 12-channel HDMI output
D6953: 16-channel HDMI output



D6954 / D6955 / D6956 / D6957

2K HD Digital Distributed Output Terminal

D6954: 20-channel HDMI output
D6955: 24-channel HDMI output
D6956: 28-channel HDMI output
D6957: 32-channel HDMI output



DSP92 Recording and Broadcasting System

Recording and broadcasting systems are technologies used to capture and transmit audio or video content to a wider audience. These systems are commonly used in various fields, such as entertainment, news, education, and business.

A recording system is a device or software that captures audio or video content and stores it for later playback or editing. This system include digital audio recorders, video cameras, or computer-based recording software. A broadcasting system, on the other hand, is a technology used to transmit audio or video content to a larger audience. This could include radio or television broadcasting, live streaming on the internet, or video conferencing. Broadcasting systems are commonly used in education such as online classes, and in business for virtual meetings and presentations.

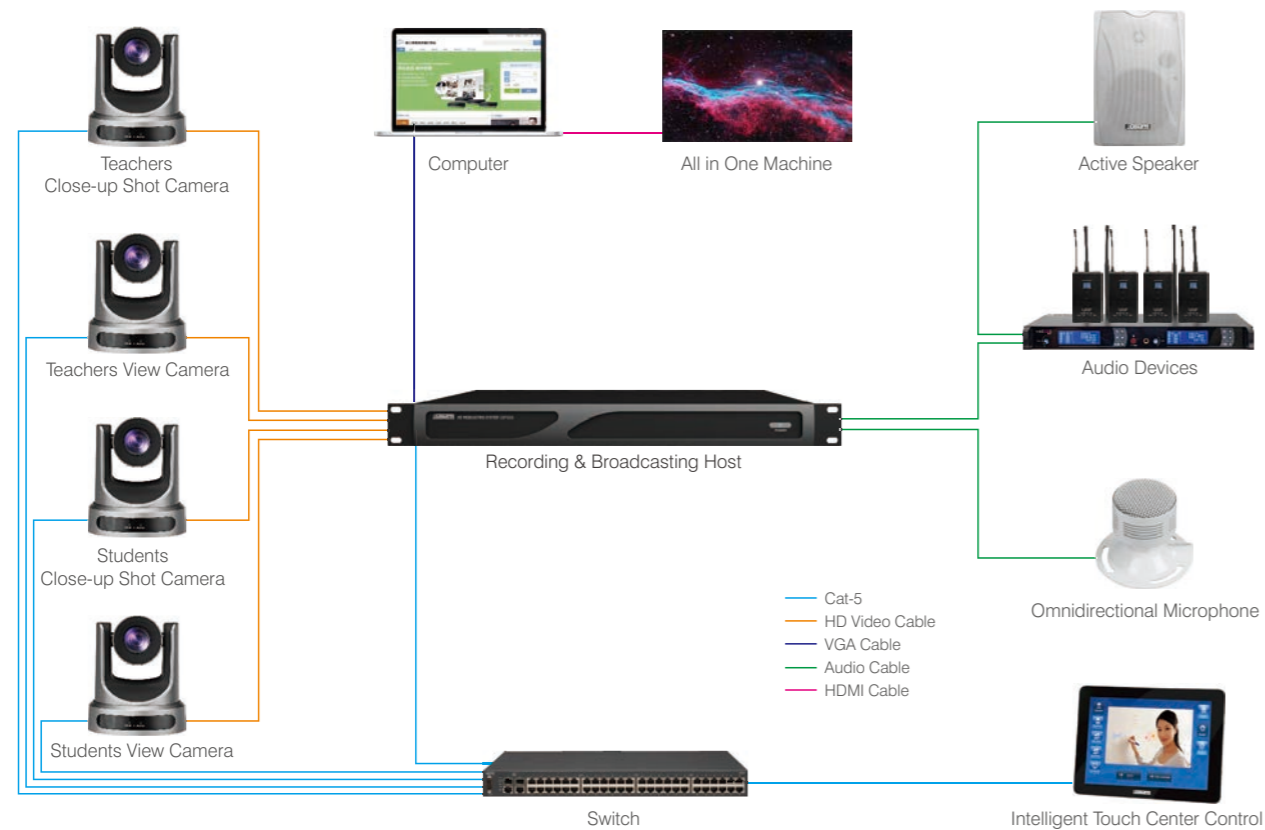

DSP9220 Resource Management Software



- DSPPA Educational Resources Cloud Platform to display and share the video resources through the display mode of the national Open Class platform, through the front-end recording and broadcasting classroom for the collection of educational resources, realize the resource integration application on the platform. The educational resources cloud platform is equipped with the basic management function, the micro-course application, the network teaching and research application function module, omni-directional promotion education fair development in the region.

DSP9201 HD Conference Recording and Broadcasting Host



- Support 2 channels SDI HD input, 2 channels HDMI input, 2 channels VGA input, 1 channel HDMI output, 1 channel VGA output, 2 channels USB interfaces
- HD video resolution of 1920*1080, adopts H265MP and H264HP for video encoding
- Support host local hard disk video file playback, USB video file playback, and remote RTSP video streaming playback and recording
- Support 12 different split-screen layout modes and user-defined split-screen layout mode settings
- Built-in digital intelligent audio processing module
- Meet the needs of daily recording, equipped with a 2T storage capacity

DSP9209 Interactive Recording & Broadcast Host



- HD video resolution support 1920*1080, adopts H265MP and H264HP for video encoding
- Input interface: 6 HD-SDI HD input, 2 HDMI input, 2 VGA input
- Output ports: 1 HDMI output, 1 VGA output, 2 USB ports
- Built-in digital intelligent audio processing module
- Integrated with recording and broadcasting and tracking function
- Supports one-button playback, manual and automatic playback modes
- Host has interactive teaching function, built-in 6 point video interactive MCU function, support standard protocol H.323
- Support cloud platform access, form high-quality resources uploading and sharing and multi-user watching live broadcast, support up to 200 users
- Equipped with 2 TB storage space and 1000 MB network port, the host can connect to a third-party FTP server and record files

DSP9202 Quality Class Education Recording & Broadcasting Host



- H.264 high-definition video encoding and AAC high-definition audio encoding
- Linux operating system, HD 1080P recording and live streaming resolution
- Direct analysis using 1080P PTZ camera
- Adopt DSPPA's unique face recognition technology and 3D mapping technology, find that person accurately among thousands of people
- 4 channels HD-SDI video signal input interface, 1 channel VGA/HDMI computer signal input interface, and 1 channel 3.5mm audio input interface
- With DVI/HDMI video output interface, supports real-time HD monitoring

DSP9221 Meeting Room Touch Controller



- With DC 12V power supply, support LAN, HDMI, USB connect
- With Android system by defaults, support Windows and Android system
- Supports free switching of recording and broadcasting hosts
- Automatic guide mode and manual guide mode for optional
- Support remote recording and broadcasting control
- Support preview of PVW and PGM images
- Support switching PVM layout and streaming
- Support remote PTZ control
- Support remote startup and shutdown of recording and broadcasting host, by same Network connection
- Support system upgrade, which can be realized by inserting USB flash disk

DSP9273 Intelligent Audio Processor



- 8 channels balanced microphone input, support phantom power 48V supply
- 4 channels balanced line input
- 6 channels balanced line output
- With 3.5 mm monitoring earphone interface
- Support one key to restore factory settings
- 48 KHZ sampling rate, A/D and D/A, 24 - bit
- With RJ-45 interface for remote control and setting
- With RS-232 serial interface for third party control

DSP9231 Omnidirectional Condenser Boundary Conference Microphone



- Element: Back Electret Condenser
- Polar Pattern: Omni-directional
- Frequency Response: 50Hz~16kHz
- Sensitivity: -38dB±3dB (0dB=1V/Pa at 1kHz)
- Output Impedance: 200Ω±30% (at 1kHz)
- Operating Voltage: DC 9~52V Phantom

DSP9212 HD Conference Recording Camera



- 72.5° wide-angle focus lens +16x digital zoom
- 1920×1080P full high definition
- Support H.265 encoding video conferencing camera
- Output frame rate can reach 60fps at 1080P, up to 120fps at 720P
- Built-in face detection module for PTZ tracking (optional)
- Support AAC audio encoding and local storage function
- Support HDMI output with 3G-SDI interface, transmission distance 150 meters
- Using RS232 and RS485 serial ports to control the camera
- Support the image freezing function of the preset position process

DSP9235 Pendant Conference Microphone



- Powered by 48V phantom power or AA 1.5V battery
- Adopt alloy shell, to effectively reduce the interference of RF radio frequency signals
- Element: Electrostatic condenser
- Polar Pattern: Cardioid/Super-cardioid
- Frequency Response: 50Hz-16KHz/80Hz-14KHz
- Sensitivity: -45dB±2dB/-30dB±2dB
- Output Impedance: 500Ω/1600Ω±30% (at 1KHz)
- Load Impedance: ≥1000Ω
- Working Voltage: 1.5V AA battery or 9-52V phantom power
- Net Weight: 270g

HD8000 Video Meeting Conference System

The remote video conference system refers to the remote video conference system devices for two or more individuals or groups in different places to share and send files and images in the meeting for instant and interactive communication by using microphone speaker equipment including cameras, display devices, microphones and speakers through the Internet transmission cable. This system is a typical image communication, as the images and sound signals are converted into digital signals at the sending end of the communication, and then reproduced as visual and auditory information at the receiving end. Compared with the telephone conference, it is more intuitive and has more information. By using the remote video conference system, you can not only hear the sound, but also see the conference participants, jointly facing the problems to be discussed, studying the drawings and objects, which is no different from a real conference, so that every participant has an immersive experience.

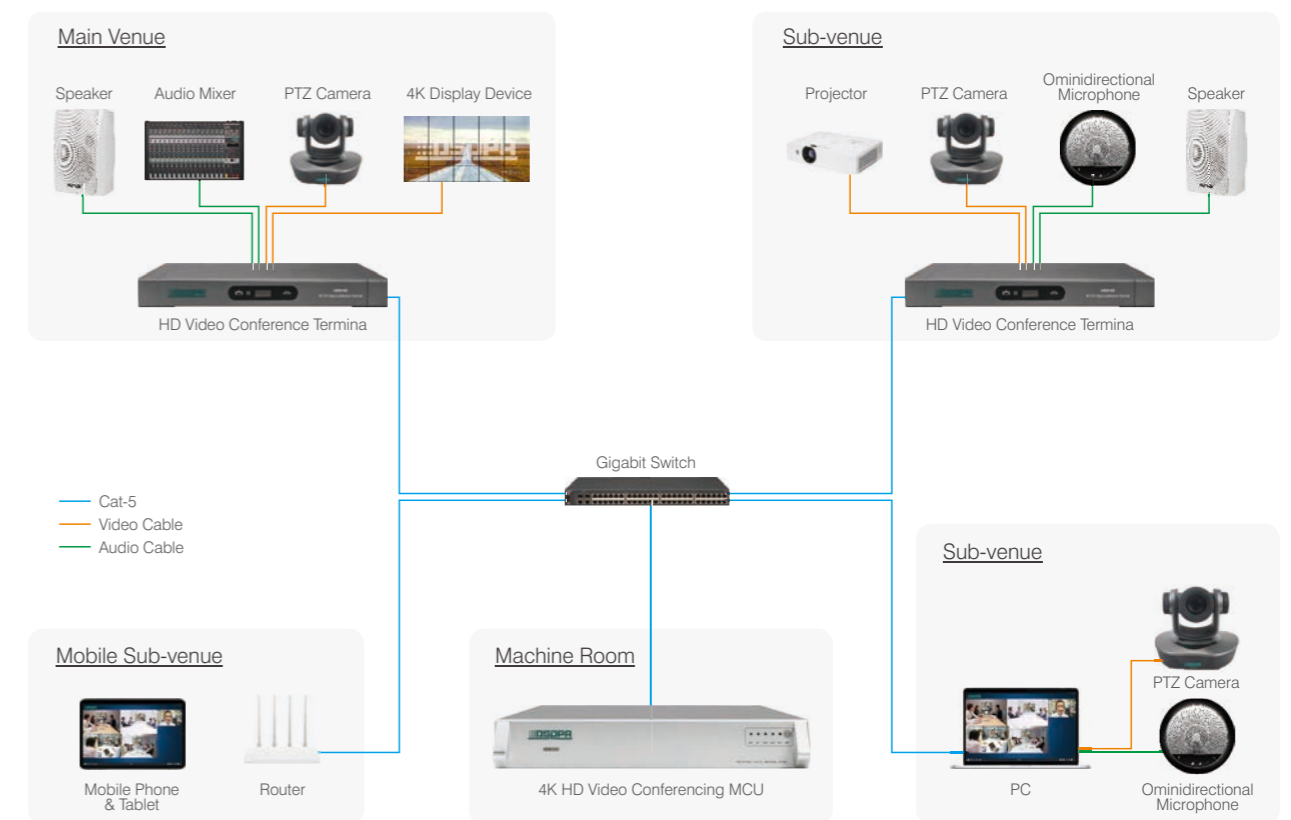

HD8110 HD Video Conference System PC Software



HD8112 HD Video Conference System Android Software



HD8000

4K HD Video Conference MCU (9-128 channels)



- 9/16/24/10/40 Channels MCU
- Remote HD video conference system MCU
- Adopt industrial advanced H.323 High Profile technology
- Compatible with other brand MCU product
- Support HD & high bit stream data transmit
- Support upto 128 channels MCU

HD8107

Integrated Video Conference Terminal (Android)



- Integrated 1080P HD camera, array microphone, speaker
- Dual-purpose: conference camera and video camera for PC
- Support dual HDMI output, display in full screen
- Multi-protocol integration, standard SIP protocol
- Support Android video conference software such as Zoom, DingTalk and Tencent

HD8014

Desktop Omnidirectional Microphone



HD8015

Desktop Omnidirectional Microphone



HD8018SH

HD Video Conference Tracking Camera



HD8102

HD Video Conference Terminal



D7702

High-end Dante Array Ceiling Microphone

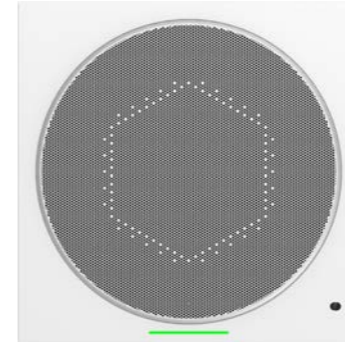

USB-C Debugging Port
RJ45 Connection to PoE Network Switch



- High density microphones array (128 units)
- Preferred pickup zones & block area
- Dynamic multi-beam voice tracking
- Enhanced speech intelligibility for every word from multiple speakers
- Ultra-low latency (25ms) with high gain (10dB)
- Advanced AFC noise reduction algorithm blocks background noise
- Built-in PTZ camera audio tracking functionality

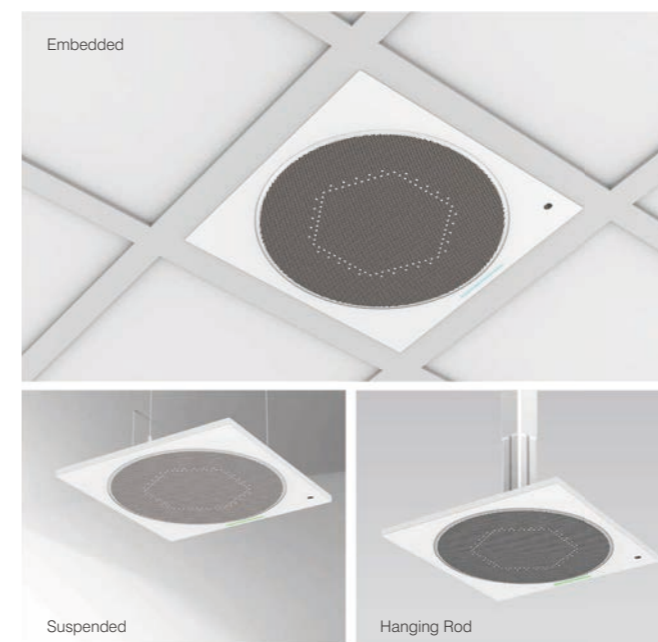

D7700

Video Conference Collaboration System



D7703

Omnidirectional Microphone



D7705

Wireless Cascading Omnidirectional Microphone



D7701
Video Conference Intelligent Terminal



- Camera/microphone/speaker, all-in-one design
- 4K lens(8 mega pixels CMOS sensor), 120°(90° optional)
- Frame rate: 4K@30fps, support 2K, 1080P, 720P, 480P, 360P
- HDMI video output
- AI functions: Intelligent facial detection, tracking, framing
- Voice pickup distance 8m
- Speaker power 2*15W
- DSP(AEC/AGC/ANC)
- Support to connect to local audio processor/mixer/ microphone system
- 4 advanced audio processing technologies:
 - * Echo cancellation
 - * Intelligent noise suppression
 - * Automatic gain control
 - * Reverberation

DSP2102
4K 2 Channels Wireless Screen Mirroring Receiver



- Support 2 devices screen share to TV at the same time
- Compatible with Windows, MacOS, Android, iOS
- With HDMI/USB/Type-C transmitter, plug and play with free drive
- 4K HD quality,5G WiFi transmit, more reliable and stable
- With password access, conference management function
- Built-in bluetooth module, support Sound and picture synchronization
- With external antenna, support max 30 meters screen mirroring
- With USB interface for displaying the file in USB
- Support screen share for phone, pad, PC etc.
- Suitable for conference meeting, business presentation, training or personal entertainment



D103
Type-C Transmitter

DC2804
Panoramic 360-degree Video Conference Camera



(Tripod bracket is optional)

- 360-degree panoramic conference camera
- Built-in 4 pcs 1/2.8 inch 2 million pixel CMOS
- Omnidirectional microphone+3A algorithm
- Integrated with panoramic camera and omnidirectional microphone and bluetooth speaker
- Pickup Radius: 3meters
- AI Audio-Visual Speaker Localization & Tracking Algorithm
- With 4W full-range hi-fi speakers, provide extraordinary sound effects
- Multi mode: Panorama + Close-up Tracking Mode, Panoramic Split-Screen Mode
- Cascading magnetic power bank
- Audio coding: G711A/PCM/AAC
- Video coding: H2.64/MJPEG 1080P@25/30fps
- With TYPE-C interface, can be connected with a computer or a large commercial display screen

DSP2103
4K HD Wireless Screen Mirroring System



- Compatible with Windows, MacOS, Android, iOS
- With HDMI transmitter,plug and play with free drive
- 4K HD quality, 2.4G/5G dual-frequency, make sure the system more stable
- With external antenna, support max 30 meters screen mirroring
- 3.5mm interface for professional audio input
- With VGA for connecting with Screen
- Support screen share for phone, pad, PC etc.
- Suitable for conference meeting, business presentation, training or personal entertainment

DCP-8665L / DCP-8675L / DCP-8686L / DCP-8698L

65" / 75" / 86" / 98" Intelligent Interactive Flat Panel



- Aluminum alloy outer frame
- 4mm physically tempered anti-explosion glass
- Windows 40-point and Android 20-point touch writing experience
- Standard OPS slot with an integrated pluggable design
- 1*USB 3.0, 1*USB 2.0, 1*HDMI IN, 1*TOUCH IN, 1*Type-c
- Front-facing speakers with 15W x2 output
- One-key activation of "Ops" via the front button
- Built-in electronic whiteboard and annotation function

Model	DCP-8665L	DCP-8675L	DCP-8686L	DCP-8698L
Screen Size	65 Inch	75 Inch	85 Inch	98 Inch
Assembly Technology	Zero-bonding			
Backlight Type	DLED direct-lit			
Screen Ratio	16: 9			
Physical Resolution	3840* 2160			
Brightness	300-350cd (Center Brightness)		350cd (Center Brightness)	
Contrast Ratio	4000: 1	5000: 1	4000: 1	6000: 1
Color Gamut	72%			
Display Color	1.07B (8-bit+Hi-FRC)			
Viewing Angle	178°			
Refresh Rate	60Hz			
Response Time	8ms			
Touch Type	Infrared Touch			
Supported Touch OS	Windows XP / Windows 7 / Windows 10 / Linux / Android			
PC Type	Plug-in Intel Core Series Modular OPS Module			
Android Version	Android14			
CPU	A55×8, 1.2GHz, up to 1.5GHz			
GPU	G52×4 (4 Core)			
Memory	4GB+32GB (Optional: 8GB+128GB)			
WiFi or Bluetooth	Wi-Fi 5 (2.4GHz + 5GHz) + Bluetooth 5.0			
Dimension (mm)	1493×908×87.9	1714.8×1032.5×88	1961.2×1171.9×88	2217.84×1326×95
Net Weight	41.5kg	50.4±1kg	68.5±1kg	97.5±1kg

DCP-8665LCM / DCP-8675LCM / DCP-8686LCM / DCP-8698LCM

65" / 75" / 86" / 98" Intelligent Interactive Flat Panel with Camera and Array Microphone



- With 1*Camera(48MP, D:80° H:75° V:50°) and 8*Array Mic(<8M)
- Aluminum alloy outer frame
- 4mm physically tempered anti-explosion glass
- Windows 40-point and Android 20-point touch writing experience
- 1*USB 3.0, 1*USB 2.0, 1*HDMI IN, 1*TOUCH IN, 1*Type-c
- Front-facing speakers with 15W x2 output
- One-key activation of "Ops" via the front button
- Built-in electronic whiteboard and annotation function

Model	DCP-8665LCM	DCP-8675LCM	DCP-8686LCM	DCP-8698LCM
Screen Size	65 Inch	75 Inch	85 Inch	98 Inch
Assembly Technology	Zero-bonding			
Backlight Type	DLED direct-lit			
Screen Ratio	16: 9			
Physical Resolution	3840* 2160			
Brightness	300-350cd (Center Brightness)		350cd (Center Brightness)	
Contrast Ratio	4000: 1	5000: 1	4000: 1	6000: 1
Color Gamut	72%			
Display Color	1.07B (8-bit+Hi-FRC)			
Viewing Angle	178°			
Refresh Rate	60Hz			
Response Time	8ms			
Touch Type	Infrared Touch			
Supported Touch OS	Windows XP / Windows 7 / Windows 10 / Linux / Android			
PC Type	Plug-in Intel Core Series Modular OPS Module			
Android Version	Android14			
CPU	A55×8, 1.2GHz, up to 1.5GHz			
GPU	G52×4 (4 Core)			
Memory	4GB+32GB (Optional: 8GB+128GB)			
WiFi or Bluetooth	Wi-Fi 5 (2.4GHz + 5GHz) + Bluetooth 5.0			
Dimension (mm)	1493×908×87.9	1714.8×1032.5×88	1961.2×1171.9×88	2217.84×1326×95
Net Weight	41.5kg	50.4±1kg	68.5±1kg	97.5±1kg

DCP-65H / DCP-75H / DCP-86H / DCP-98H / DCP-110H

65" / 75" / 86" / 98" / 110" Intelligent Interactive Flat Panel with Camera and Array Microphone

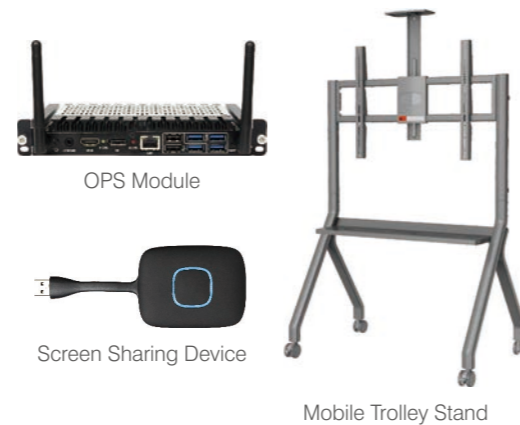

- Original A grade panel, 4K resolution
- Android 14.0, 4GB DDR Memory+32GB ROM Storage, CPU: Cortex-A55x8 core, GPU: Mali-G52x4
- Front Panel Interfaces: USB 3.0x3, HDMI inx1, Type-Cx1, Touch Outx1, Standard 8 Physical Buttons
- Built-in 48MP camera and 8-Channel array microphone
- Front-facing speakers with 16W x2 output
- Patented back plate abrasive tool One-piece molding, simple and stylish
- Front physical buttons and interfaces, Easy and convenient operation
- Interval sound design, Eliminates tremolo interference
- Pluggable WiFi module, WiFi5 2.4G+5G+Bluetooth
- Compatible with dual systems, Supports OPS and Android dual systems
- OPS module is optional

Model	DCP-65H	DCP-75H	DCP-86H	DCP-98H	DCP-110H (Customized)
Screen Size	65 Inch	75 Inch	85 Inch	98 Inch	110 Inch
Assembly Technology	Zero-bonding				
Backlight Type	DLED				
Screen Ratio	16: 9				
Physical Resolution	3840* 2160				
Brightness	≥350cd/m ²				
Color Gamut	72%				
Display Color	1.07B (10bit)				
Viewing Angle	178° (H/V)				
Refresh Rate	60Hz				120Hz
Response Time	6.5ms				8ms
Touch Point	40 points touch				
Supported Touch OS	Windows 10 / Windows 8 / Windows 7 / Windows XP / Android / Linux / MacOSX / Chrome				
PC Type	Plug-in Intel Core Series Modular OPS Module				
Dimension (mm)	1485×900×86	1707×1025.7×87	1953×1164×88	2216×1317×108	2500×1477×105
Net Weight	33.6kg	44.3kg	57.2kg	89.4kg	112.5kg

DCP-8755 / DCP-8765 / DCP-8775 / DCP-8786 / DCP-8798 / DCP-8711

55" / 65" / 75" / 86" / 98" / 110" Dual-System Conference Tablet



- 4K soft screen, tempered high-transparency glass optical anti-glare
- Backlight scheme: D-LED type, color gamut: 85%NTSC (typical value)
- Android 14.0, 8GB DDR Memory+128GB ROM Storage, CPU: Cortex-A55x8 core, GPU: Mali-G52 MP2
- Front Panel Interfaces: USB 3.0x2, HDMI inx1, Type-Cx1, Touch Outx1
- 40-point high precision touch scheme, supporting single point/multi-point touch and writing
- Front surround dual speakers, active noise reduction: full bass, bright high sound
- Compatible with dual systems, Supports OPS and Android dual systems
- OPS module is optional



Model	DCP-8755	DCP-8765	DCP-8775	DCP-8786	DCP-8798
Screen Size	55 Inch	65 Inch	75 Inch	86 Inch	98 Inch
Backlight Type	DLED				
Screen Ratio	16: 9				
Physical Resolution	3840* 2160				
Color Gamut	85% NTSC (typical value)				
Touch Point	40 points touch				
Support OS	Windows / Android				
PC Type	Plug-in Intel Core Series Modular OPS Module				
Android Version	Android14				
CPU	A55×8				
GPU	Mali-G52 MP2				
Memory	8GB+128GB				
Dimension (mm)	1265.6×763×85	1485.8×888×84.8	1708×1013.2×85	1954×1152.9×86.1	2217.6×1305×96
Net Weight	23kg	32kg	45kg	56kg	80kg

D6601 Distributed Central Control System

D6601 distributed central control system is a type of system used in various industries and applications to manage and control various processes, devices, or equipment from a centralized location. It is a network of interconnected devices, sensors, and controllers that work together to monitor and control various parameters of the system. Our system integrated the control of lighting, equipment, projection and audio-visual device, to provide a simple and direct control interface, so that users can easily grasp the status and functions of the equipment of the entire space environment.

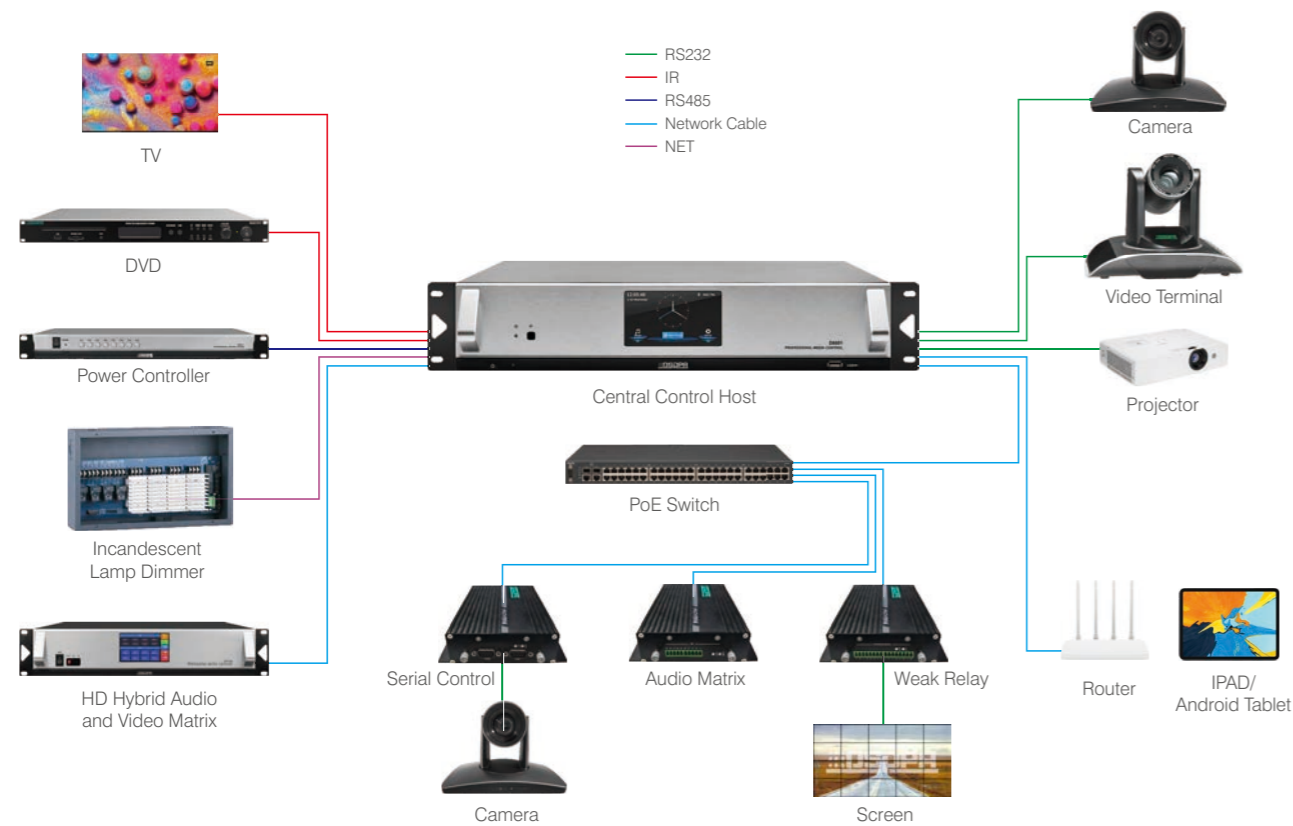

D6601 Distributed Central Control System Host



- 4.3-inch touch screen control, using programmable control platform
- Using functioncard architecture, can be inserted in the host, also can be distributed placement through extension terminal
- Own program player, can play MP3, WAV, WMA, FLAC, APE, AAC, M4R, M4A, OGG, WV format music
- Can edit 200 timing points, timing control program and equipment
- Built-in intelligent infrared learning module, supports infrared learning function
- Support voice recognition, remote control equipment
- Built-in 1GB DDR RAM, 8GB EMMC FLASH
- It has one 100Mbps network interface and two 100Mbps network interfaces with +48V output
- Wide voltage power supply (110V-240V) suitable for any area



D6602/D6602T
Low Current Relay Module/Terminal



D6603/D6603T
IR Control Module/Terminal



D6604/D6604T
IO Control Module/Terminal



D6605/D6605T
NET Bus Module/Terminal



D6606/D6606T
Serial Communication Control Module/Terminal



D6607 / D6607T
Serial Communication Extension Module/Terminal



D6608 / D6608T
Zigbee Control Module/Terminal



D6609 / D6609T
RF Control Module/Terminal



D6610 / D6610T
LoRa Control Module/Terminal



D6611 / D6611T
GPS+BDS Timing Calibrat Control Module/Terminal



D6612 / D6612T
4 Channels Volume Control Module/Terminal



D6613
4 Channels Incandescent Lamp Light Modulator



D6618
8 Channels Power Controller



D6614
8 Button On-wall Control Panel



D6615
Voice-activated Terminal



D6616
4 Inch Touch Screen



D6617 / D6617W
10 Inch Wired Touch Screen



D6621
Wallmount Extension Terminal



D6631
2 Ports Rack-mounted Extension Terminal



D6632
3 Ports Rack-mounted Extension Terminal

DSP6468 Multimedia Teaching Central Control System

The central control system for the classroom can greatly enhance the teaching and learning experience for both teachers and students. This system can be used to control and manage the various technological tools in the classroom, including projectors, sound systems, lighting, and other audio-visual equipment. The benefits of central control system in the classroom include improved efficiency, increased interactivity, and facilitate collaborative learning among students.

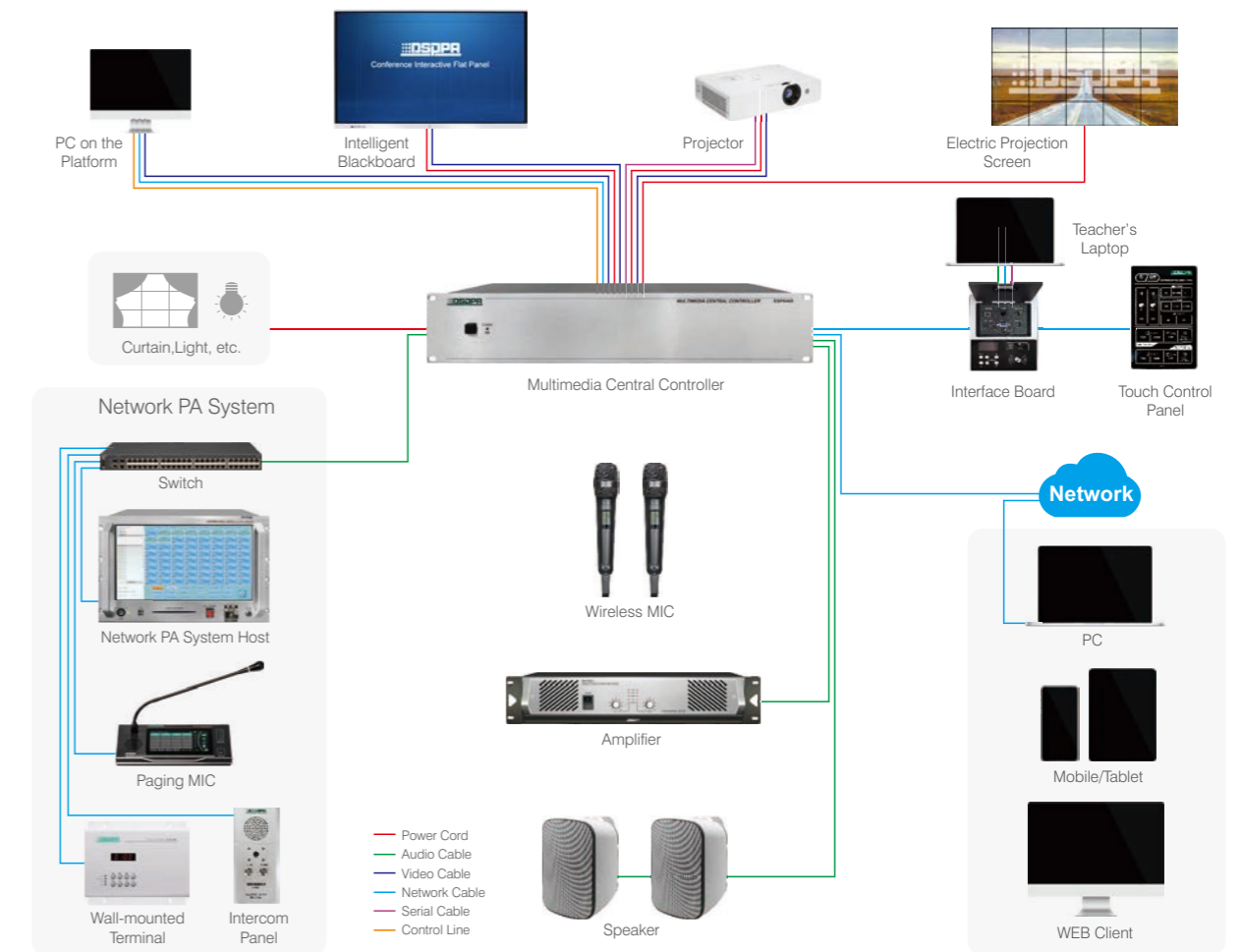

DSP6468P

Multimedia Teaching Central Control PC Software

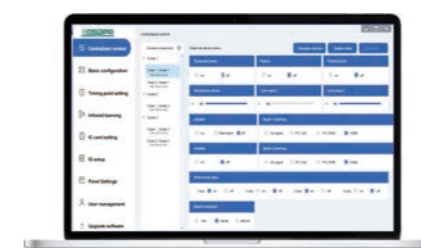

- Based on TCP/IP network communication mechanism, the data transmission is stable
- Connect multiple central control host, and monitor the connection status of the host in real time
- Support online infrared learning function, infrared device code recording, serial port configuration list
- You can set multiple scenarios based on different requirements
- Support timing function for specific scenario
- Add, edit and delete user for the WEB and Android terminals

DSP6468 Multimedia Teaching Central Control Host



- With five expansion slots for inserting module with different functions
- Supports PC control and touch panel control, Android APP control, WEB centralized control
- Supports two 100M RJ-45 ports, two RS485 ports, and four RS232 control ports
- Support video interface matrix input and output, the maximum support 1920x1080@60Hz resolution
- Support 1 channel wired microphone input, 2 channels UHF receiver input
- Supports 1 AUX input, 1 network audio input, and 1 HDMI audio input
- Network audio input has the highest priority, other audio has the second priority
- Supports four short-circuit switch signals, two I/O triggers, and two infrared outputs
- Support 2 channels AC220V power supply for external equipment, 1 channel of AC220V for electric curtain
- The host supports wide voltage power supply 110V-240V, suitable for any area



DSP6471
Touch Screen Panel



DSP6473
2 Channels UHF Microphone
Receiving Module



D7240
Intelligent IC Card Reader



DSP6474
Amplifier Module



DSP6472
Interface Adapter Panel



DSP6475
Network Module



D7241
Intelligent IC Card

D6391 16 Channels Interpretation Host



- With 2.4" TFT Screen
- Using DQPSK digital modulation technology
- 2-4MHz frequency band eliminates disturbance from all types of lighting system
- Full digital audio processor technology, sampling rate 44.1Khz
- Three working mode: Normal, Auxiliary, Alarm
- Support max 16pcs interpretation microphone powered by host

D6392 16 Channels Interpretation Microphone



- The translation unit can speak and listen at the same time
- Each translation unit needs to set an ID number (01-16)
- Supports 3.5 port earphones and headsets
- Shuttle can adjust the monitoring volume and function Settings
- 5-inch TFT color screen, display unit ID number, network connection, listening volume, speaking time, etc.
- Powered by DC 12V adapter or POE switchch

D6393 Interpretation Headset Conference Earphone



- 16 channels earphone for D6391, can be used to monitor the audio outputs
- Hi-Fi sound effect, reproduce real voice/sound
- 1.5m connection wire, convenient to use
- Excellent artificial mechanics design, ensure comfort of end-users

D6394 Infrared Radiation Panel



- The radiation panel can be connected hand in hand to enhance the coverage
- Adopt foldable design, can flexibly adjust the launch Angle
- With delay gear adjustment, to ensure that the signal is correctly superimposed transmission
- It can be fixed (equipped with universal support) or installed with triangular support
- Super launching ability, the distance of a single machine can reach 30 meters
- Coaxial line with host RF signal 150m

D6395CB 30 Channels Battery Charging Box



- AC110V-220V AC power supply
- Can charge 30 receiving units at the same time
- With telescopic rod and pulley for easy movement
- With charging protection and indication function

D6395 Infrared Receiver



- Adopt DQPSK digital demodulation technology and filter design. Has better stability
- Continuous operation up to 16 hours
- With volume adjustment, channel adjustment, low power automatic shutdown, power down data storage functions
- The interface has channel number display, power display, signal receiving strength display, volume display functions
- Support D6395CB charging box and Type-c charging
- With charging indicator function

D6390A / D6390B / D6390C / D6390D / D6390E / D6390F / 10m / 20m / 30m / 40m / 60m / 100m Connection Cable for Radiation Panel



D6215II 12 Channels Interpretation Host



- Fully digital wireless transmission technology
- System conforms to IEC61603, part 7
- 2-8MHz frequency band eliminates disturbance from all types of lighting systems
- The system provides multichannel 4/8/12/16 for option
- High security, prevent external interference
- Elegant configuration in accordance to ergonomics
- 160x32 dot matrix LCD display system information
- Installation: 19-inch frame

D6229II 12 Channels Interpretation Microphone



- Digital audio processing and transmitting technology
- Up to 16 Channel audio signals transmitted on a dedicated 12P-DIN cable
- Interpreter consoles powered by the transmitter
- Voice adjustable and with prevention on feedback
- Ensure that every channel is correspondent to the RELAY function respectively
- Delegates speak too fast; give a request for slow the speed
- Automatic numbering on system units
- Prevention on interpreter's cough
- LCD can display input and output channel

D6324II Infrared Radiation Panel

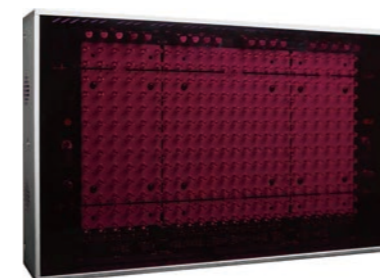

- Fully digital wireless transmission technology. System conforms to IEC61603, part 7
- Radiates & distributes up to 16 channels of digital audio signal
- Digitized audio ensures very high audio quality
- Powerful compression techniques enable efficient, low-loss transmission
- Mounted on ceiling, wall, floor stand or optional tripod
- Easily daisy-chained together to expand coverage
- Angle of half intensity: $\pm 22^\circ$

D6325II
12 Channels Infrared Receiver



- Fully digital wireless transmission technology
- Receiver conforms to IEC61603, part 7
- Pocket size wireless handheld unit
- Accommodates up to 16 different languages
- Channel selector and headphone connector
- Power on/off switch and volume level control
- Powered by (2 x AA) rechargeable batteries
- 2-digit LCD display with battery and reception status indication



D6329

Interpretation Headset Conference Earphone



D6331

Headset Conference Earphone

D6326II
26 Channels Battery Charging Box



- The charging unit can recharge up to 24 pieces receivers at once
- The charging unit contains the power supply with automatic input voltage selection
- The charging electronics and a charging indicator LED are integrated in each receiver



D6330

Single Hanging Conference Earphone



D63R

Repeater

DN20
20 Channels Rack-mounted Digital Mixing Console



- Support free switching of MIC IN and LINE IN
- With 48V phantom power for each channel
- Can be controlled through the web
- With input and output gain controller, feedback suppressor, equalizer, mixing, reverberation, compressor, and other DSP functions
- With feedback suppression function switch for each MIC IN
- With matrix mixing and reverberation control functions
- With TCP/IP protocol, various parameters can be adjusted on the web page

MAG2107C
Multifunctional CD Player with Bluetooth



- Supports CD/USB/SD card
- Imported digital movement is adopted, system+ESS decoding scheme and super error correction function
- Microcomputer control with light touch button
- Supports FM/AM digital radio
- Stereo radio, CD/MP3, bluetooth L/R output
- Mixed audio output
- FM/AM radio can store 40 stations respectively
- LCD displays working status of CD, MP3, radio, bluetooth

D6576
Automatic Feedback Suppressor



- 2 channels auto feedback suppressor
- Built-in high-end high-speed floating point digital signal processor and adaptive feedback notch processing algorithm technology
- XLR and RCA interfaces for audio inputs and outputs
- 4*8 segments of real-time level display indicator
- Each input has 15 adaptive notch filters
- TCP/IP control protocol
- Support multi-gear analog volume adjustment
- With RS232 and RJ-45 interface for communication

D6575
Professional Audio Processor



- 2-inch LCD display screen, multi-function adjustable knob
- Support 48KHz sampling frequency, built-in 32-bit DSP processor, support 24-bit A/D and D/A conversion
- Support 2 optional audio signal input, 6 audio signal output, 5 microphone input
- Support U disk MP3 playback, support Bluetooth playback
- The maximum output delay is 100ms
- The "LOCK" key on the panel
- Provides USB port for computer connection
- Provides storage and switching of 16 scenes

D2100F
Digital Feedback Suppressor



- Adopt a high-performance professional audio processor
- With 4 balanced/unbalanced microphone inputs and 1 balanced/unbalanced output
- With 1 line signal input and 1 line signal output
- With a TFT color screen for displaying spectrum signals and operating status
- With signal level indication and BYPASS/ACTIVE switch
- With 48V phantom power switch and separate volume control for 4 microphone inputs

MAG2123S

8 Channels Power Supply Sequence Controller



- Sequentially switching power supply for 8 channels
- Step time: 0.4S-0.5S
- Power capacity: 220V, 10A
- Max output of each socket is 10A
- Total input current capacity is 10A
- Universal socket, suitable for different types of plugs
- Turn on/off the amplifier in sequence to avoid high current to damage the amplifier or the power supply system

D6572II

8 Channels Power Supply Sequence Controller



- 8 channels individual big power output
- Universal socket, can meet the needs of various types of plug
- Total Max current 16A, each channel Max current 10A
- Each channel will be turned on/off in order, so as to protect the power grid
- With activating trigger of 6.3mm phone jack interface
- Power supply: AC 220-240V/50-60Hz/20A

D6578

8 Channel Power Supply Sequence Controller



- 8 channels individual big power output
- Universal socket, can meet the needs of various types of plug
- Each channel Max current 10A output
- Each channel will be turned on/off in order, so as to protect the power grid
- Support RS232 RS485 and central control protocol
- Power supply: AC 220-240V/50-60Hz/20A

D6721S

Sequence Controller



- Universal socket, 8 channels controlled by relays and 2 channels with direct output
- Total Max current 30A, each channel current 13A
- Features real-time voltage monitoring via digital display
- Ensures safe startup/shutdown sequence for AV equipment
- 5000W/8000W (maximum reactive power)
- Flame-retardant ABS material
- Switch interval time per channel: 1 second
- Power input: AC90-260V/50-60Hz

D6720

Intelligent Power Controller



- 8 channels individual power output, each channel 10A/16A
- 2 channels of direct power supply in front panel, each channel 10A
- Universal socket, can meet the needs of various types of plug
- With 2.4" LCD display screen
- Each channel Max current 16A output in rear panel
- Each channel will be turned on/off in order, so as to protect the power grid
- RS485 serial port to connect with the central control system
- Power supply: AC 220V/50Hz/25A

D5831AI

AI Conference Microphone



- Ultra-long pickup distance, max up to 1 meter
- With intelligent noise reduction function
- With real-time feedback suppression function
- With 2m dedicated 8-pin DIN high-density cable
- Square microphone pole with 240mm
- With a junction box, and the input voltage is 12V
- Two channel RCA sockets for unbalanced input
- A 3P balanced output XLR socket



AI Audio Interface Box

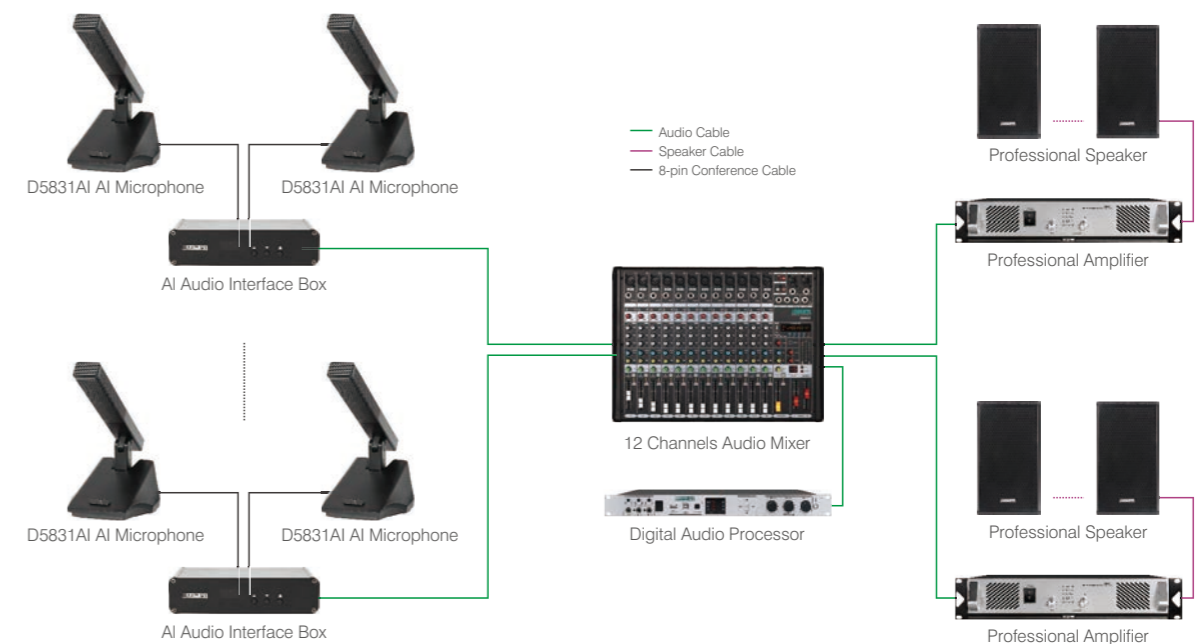

D7401
AI Digital Conference Host



- Features a 0.96 - inch OLED screen
- Allows setting the limit of simultaneous speakers (1/2/3/4/5/6)
- Supports five conference modes: First-In-First-Out, Free, Normal, Application
- Volume adjustment function to regulate output signal level
- Can connect up to 32 AI desktop speaker units
- Equipped with 1 RS485 serial port
- Can seamlessly access AI voice transcription systems (D7601, D7604) via network
- 1 RJ45 network interface supporting TCP/IP protocol

D7411
AI Desktop Chairman Microphone



- Ultra-long pickup distance, max up to 1 meter
- With intelligent noise reduction function
- With real-time feedback suppression function
- With 2m dedicated 8-pin DIN high-density cable
- Square microphone pole with 240mm
- It has a microphone on/off key
- With a unique ID for each conference unit
- With automatic camera tracking function
- The microphone is powered by host, and the input voltage is 12V

D7412
AI Desktop Delegate Microphone



- Ultra-long pickup distance, max up to 1 meter
- With intelligent noise reduction function
- With real-time feedback suppression function
- With 2m dedicated 8-pin DIN high-density cable
- Square microphone pole with 240mm
- It has a microphone on/off key
- With a unique ID for each conference unit
- With automatic camera tracking function
- The microphone is powered by host, and the input voltage is 12V

D5830
Professional Condenser Microphone



- Can suppress lateral ambient noise greater than 80dB
- Metallic texture with tempered glass inlay
- Zinc alloy die-casting, oxidized processing on the surface
- Distinctive directional characteristics in the vocal speech frequency band (100-12KHz)
- Powered by 48V phantom power supply
- Support balanced output
- With low AC internal resistance, and strong anti-interference capability

D5831
Professional Condenser Microphone



- Plug & play, easy to use
- Sensitivity: -43dB±1dB
- Wide frequency response: 100-12KHz
- Output impedance: 680Ω (Balanced)
- Power supply: phantom 48V
- Condenser Microphone
- Pick up distance: 20-60cm
- Product dimension: 370x330x186mm
- Net weight: 0.8kg

CM30
Desktop Condenser Microphone



- With full anti interference from electromagnetic/mobile phone/feedback

Capsule Type	Condenser
Sensitivity	-45dB±2dB
Output Impedance	75Ω at 1kHz
Freq. Response	30Hz-20kHz
Polar Pattern	Uni-Directiona
Micro Tube Length	455mm
Dimension	115x138x40mm
Net Weight	1.1kg

CM62
Desktop Condenser Microphone



- With full anti interference from electromagnetic/mobile phone/feedback

Capsule Type	Condenser
Freq. Response	80Hz-13kHz
Sensitivity	30mV/Pa
Output Impedance	200Ω±20% (at 1 kHz)
Polar Pattern	Ultra-cardioid
Working Voltage	DC 3V or phantom 48V
Output Type	Balanced
Micro Tube Length	450mm
Base Size	Φ130mm
Base Net Weight	0.5kg

D5837 / D5838

Dual / Four Poles Lecture Microphone



D5837

D5838

Diaphragm Diameter	25mm
Capsule Type	Condenser
Freq. Response	20Hz-20kHz
Sensitivity	25mV/Pa
Polar Pattern	Hyper-cardioid
Max SPL	150dB
Dynamic range	130dB
Power Supply	Phantom power 48V

D6560

Desktop Condenser Microphone



Capsule Type	Condenser
Freq. Response	100Hz-12kHz
Sensitivity	-35dB±3dB
Output Impedance	200Ω (at 1kHz)
Polar Pattern	Hyper-cardioid
Output Level	15mV (1kHz/94dB)
Output Type	Balanced
Working Voltage	DC 3V or phantom 48V

D6561

Wired Hand-held Dynamic Microphone



Capsule Type	Dynamic
Freq. Response	60Hz-17kHz
Sensitivity	-73dB±3dB
Output Impedance	600Ω (at 1kHz)
Polar Pattern	Hyper-cardioid
Connection	Wired Phone Jack
Dimension	188.5x51x24.3mm
Net Weight	0.285kg

D5832 / D5833

Diaphragm Microphone



D5832

D5833

Diaphragm diameter	16mm
Freq. Response	20-20kHz
Sensitivity	25mV/Pa
Polar Pattern	Hyper-cardioid
Max SPL	150dB
Dynamic range	130dB
Power supply	Phantom power 48V
Power consume	4mA